

since 1973

2019

# 4 VIOMETALE

HOME | OFFICE | HOTEL



• CUSTOM MADE INTERIOR DOORS

▽ ΕΣΩΤΕΡΙΚΕΣ ΠΟΡΤΕΣ ΣΤΙΣ ΔΙΑΣΤΑΣΕΙΣ ΤΟΥ ΠΕΛΑΤΗ



• MATCH COLOR FURNITURE PANELS  
• GLOSS & MAT PANELS • WORKTOPS

▽ ΟΜΟΙΟΧΡΩΜΙΑ ΠΟΡΤΩΝ & ΕΠΙΦΑΝΕΙΩΝ ΕΠΙΠΛΟΠΟΙΙΑΣ



• FURNITURE FITTINGS

▽ ΥΛΙΚΑ ΕΠΙΠΛΟΠΟΙΙΑΣ





## Our history

Η **Viometale** ιδρύθηκε το 1973.

Σχεδιάζει, παράγει & διανέμει σε όλη την Ελλάδα & σε χώρες του εξωτερικού πόμολα, κουρτινόξυλα & αξεσουάρ μπάνιου.

Το πάθος για συνεχή ανάπτυξη & δημιουργία, οδήγησαν την εταιρία στην κατασκευή νέων προϊόντων με πρώτη ύλη το ξύλο.

Το 2008 δημιουργήθηκε η **Viometale4Home**.

Σχεδιάζει και παράγει πόρτες εσωτερικού χώρου **στις διαστάσεις του πελάτη**, panels επιπλοποιίας, έπιπλα εσωτερικού χώρου R.T.A. (έτοιμα προς συναρμολόγηση) & εμπορεύεται πάγκους κουζίνας & υλικά επιπλοποιίας.

Στεγάζεται σε ιδιόκτητες κτιριακές εγκαταστάσεις (7.000m<sup>2</sup>) στη βιομηχανική περιοχή των Οινόφυτων, όπου και έχουν γίνει σημαντικές επενδύσεις σε εξοπλισμό προηγμένης τεχνολογίας.

Στόχος της **Viometale4Home** είναι η βελτίωση των υπηρεσιών που προσφέρει όσον αφορά την παραγωγή & εμπορία ποιοτικών προϊόντων, με σκοπό την καλύτερη εξυπηρέτηση των πελατών της.

Όραμα της **Viometale4Home** είναι η διεξόδωση σε αγορές του εξωτερικού, προωθώντας ποιοτικά προϊόντα **MADE IN GREECE**.

**Viometale** was founded in 1973.

It designs, produces and allocates throughout Greece and in other countries, door handles, curtain rods and bathroom accessories.

The passion for continuous growth and creation, led the company to build new products with wood raw material.

**Viometale4Home** was created in 2008.

It designs & produces interior doors, furniture panels, R.T.A. interior furnitures (ready to assembling) and trades kitchen worktops and furniture fittings.

It is housed in proprietary facilities (7.000m<sup>2</sup>) in the industrial area of Oinofyta, where significant investments have been made in technologically advanced equipment.

The aim of **Viometale4Home** is the constant improvement in the manufacture and trade of quality products for the better customer services.

The vision of **Viometale4Home** is the penetration in foreign markets, while promoting quality products that are **MADE IN GREECE**.





# Περιεχόμενα - Index



## Interior Doors

4 - 65

Εσωτερικές πόρτες



## Match Color furniture Panels - Gloss & Mat Panels - Worktops

66 - 78

Ομοιοχρωμία πορτών & επιφανειών επιπλοποιίας

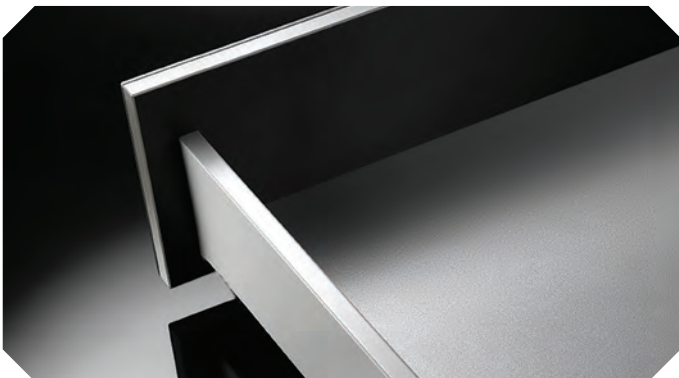

## Furniture Fittings

79 - 98

Υλικά επιπλοποιίας

**4 VIOMETALE**   
HOME | OFFICE | HOTEL



Είμαστε σίγουροι ότι το παρόν έντυπο αποτελεί ένα πολύτιμο εργαλείο για το σχεδιασμό & την υλοποίηση των έργων σας!

We are certain that this form is a valuable tool for the design and implementation of your projects!





# home

**4VIOMETALE**   
HOME | OFFICE | HOTEL



# hotel

# office



# Custom made interior Doors

made in Greece

Εσωτερικές πόρτες στις διαστάσεις του πελάτη



## Our Doors

Όλες οι πόρτες είναι κατασκευασμένες από MDF 6mm, με πλήρωση χαρτοκυψέλης & τελάρο λευκής ξυλείας FINGER JOINT.

Οι κάσες είναι κατασκευασμένες από BLOCK BOARD με διατομές 85 - 100 - 130 - 150 - 180 - 240 x 40mm, ίσιες ή οβάλ.

Όλα τα περβάζια είναι κατασκευασμένα από κόντρα πλάκε διατομής 6,5x9mm (ίσια) & 6,5x15mm (οβάλ).

Τα πορτόφυλλα φέρουν τοποθετημένη κλειδαριά καθώς και τρία διπλά βαρελάκια.

Οι κάσες φέρουν το κυτρί της κλειδαριάς, τα τρία διπλά βαρελάκια και τα λάστιχα, ενώ επίσης διαθέτουν φαλτσομόρσο.

• Οι πόρτες δεν είναι διαστασιολογημένες κατασκευάζονται στις διαστάσεις του πελάτη.

The boards are made by MDF 6mm pressed by honeycomb on a wooden frame FINGER JOINT.

All the frames are made by BLOCK BOARD in 85 - 100 - 130 - 150 - 180 - 240 x 40mm oval or linear.

The gap covers are made by PLYWOOD in 6,5x15mm (oval) or 6,5x9mm (linear).

Each door has a standard interior lock, three double hinges and rubbers.

• All doors are custom made.



## Certificates

Η VIOMETALE4HOME ακολουθεί όλα τα διεθνή στάνταρ στον τομέα δραστηριοποίησής της.

VIOMETALE4HOME is certified to all major standards concerning production.







**Τύπος & Διαστάσεις κάσας:**

Case type & dimensions:

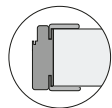

85mm  
100mm  
130mm  
150mm  
180mm  
240mm

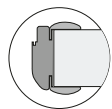

**Κωδ./Code:**

vio 06.01.MK850.Z9







Ομοιοχρωμία επιφανειών  
Match Color



• Ειδικό πάνελ  
επιπλοποιίας: 8 - 18 - 25mm

**Διάσταση πάνελ:**  
2800x1220mm

• Special furniture  
panel: 8 - 18 - 25mm  
**Panel dimensions:**  
2800x1220mm

• P.V.C.: 22/1 - 28/1



**Αριστερή Πόρτα**  
Left Door

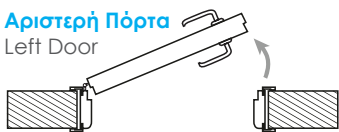

**Δεξιά Πόρτα**  
Right Door

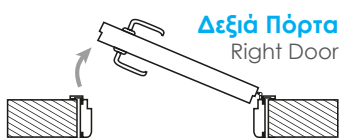

**Υφή επιφάνειας:** Haptic

**Τύπος πόρτας:** Εσωτερικού χώρου

**Κωδικός Χρώματος:** EX001 Tadao Scuffy

**Surface:** Haptic

**Door type:** Interior door

**Color code:** EX001 Tadao Scuffy





**Ομοιοχρωμία επιφανειών**  
Match Color

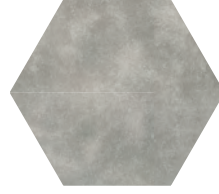

• Ειδικό πάνελ  
επιπλοποιίας: 8 - 18 - 25mm  
**Διάσταση πάνελ:**  
2800x1220mm

• Special furniture  
panel: 8 - 18 - 25mm  
**Panel dimensions:**  
2800x1220mm

• P.V.C.: 22/1 - 28/1



**Υφή επιφάνειας:** Haptic  
**Τύπος πόρτας:** Εσωτερικού χώρου  
**Κωδικός Χρώματος:** EX002 Tadao Scuffy

**Surface:** Haptic  
**Door type:** Interior door  
**Color code:** EX002 Tadao Scuffy

**Τρόποι μετατροπής:**

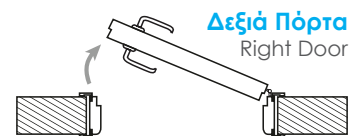
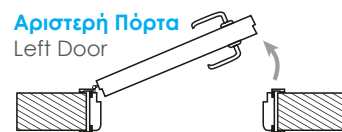





**Τύπος & Διαστάσεις κάσας:**

Case type & dimensions:

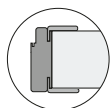

85mm  
100mm  
130mm  
150mm  
180mm  
240mm

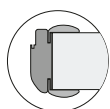

**Κωδ./Code:**

via 06.01.MK803.59

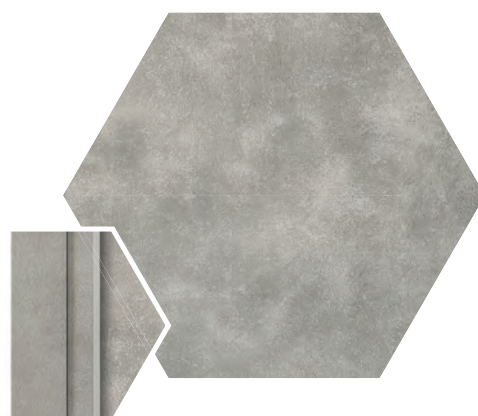





**Τύπος & Διαστάσεις κάσας:**

Case type & dimensions:

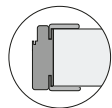

85mm

100mm

130mm

150mm

180mm

240mm

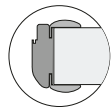

**Κωδ./Code:**

vio 06.01.1120.04





Ομοιοχρωμία επιφανειών  
Match Color

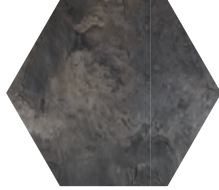

• Ειδικό πάνελ  
επιπλοποιίας: 8 - 18 - 25mm  
**Διάσταση πάνελ:**  
2800x1220mm

• Special furniture  
panel: 8 - 18 - 25mm  
**Panel dimensions:**  
2800x1220mm

• P.V.C.: 22/1 - 28/1

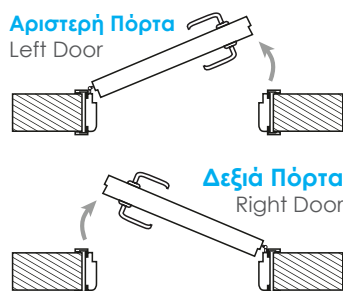

**Υφή επιφάνειας:** Klarlack  
**Τύπος πόρτας:** Εσωτερικού χώρου  
**Κωδικός Χρώματος:** EX003 Buntschiefer Monreal

**Surface:** Klarlack  
**Door type:** Interior door  
**Color code:** EX003 Buntschiefer Monreal





**Ομοιοχρωμία επιφανειών**  
Match Color

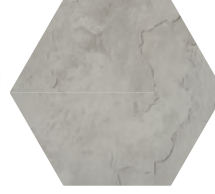

• Ειδικό πάνελ  
επιπλοποιίας: 8 - 18 - 25mm  
**Διάσταση πάνελ:**  
2800x1220mm

• Special furniture  
panel: 8 - 18 - 25mm  
**Panel dimensions:**  
2800x1220mm

• P.V.C.: 22/1 - 28/1



**Υφή επιφάνειας:** Klarlack  
**Τύπος πόρτας:** Εσωτερικού χώρου  
**Κωδικός Χρώματος:** EX004 Buntschiefer Monreal

**Surface:** Klarlack  
**Door type:** Interior door  
**Color code:** EX004 Buntschiefer Monreal

**Τρόποι μετατροπής:**

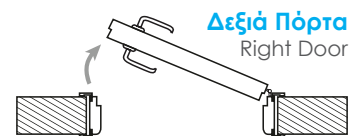
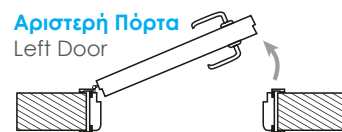



**Τύπος & Διαστάσεις κάσας:**

Case type & dimensions:

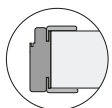

85mm  
100mm  
130mm  
150mm  
180mm  
240mm

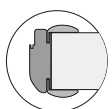

**Κωδ./Code:**

via 06.01.MK1040.Z9







**Τύπος & Διαστάσεις κάσας:**

Case type & dimensions:

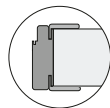

85mm  
100mm  
130mm  
150mm  
180mm  
240mm

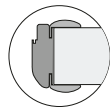

**Κωδ./Code:**

vio 06.01.1000.K4





## Ομοιοχρωμία επιφανειών Match Color



• Ειδικό πάνελ  
επιπλοποιίας: 8 - 18 - 25mm  
**Διάσταση πάνελ:**  
2800x1220mm

• Special furniture  
panel: 8 - 18 - 25mm  
**Panel dimensions:**  
2800x1220mm

• P.V.C.: 22/1 - 28/1

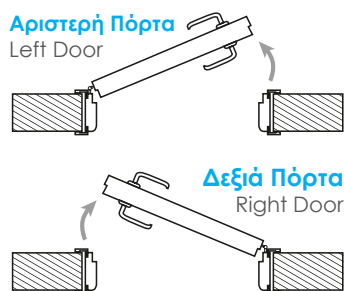

**Κατεύθυνση επιφάνειας:** Κάθετη  
**Υφή επιφάνειας:** Synchro  
**Τύπος πόρτας:** Εσωτερικού χώρου  
**Κωδικός Χρώματος:** EX005 Eiche Ribbeck

**Surface trend:** Vertical  
**Surface:** Synchro  
**Door type:** Interior door  
**Color code:** EX005 Eiche Ribbeck





**Ομοιοχρωμία επιφανειών**  
Match Color



• Ειδικό πάνελ  
επιπλοποιίας: 8 - 18 - 25mm  
**Διάσταση πάνελ:**  
2800x1220mm

• Special furniture  
panel: 8 - 18 - 25mm  
**Panel dimensions:**  
2800x1220mm

• P.V.C.: 22/1 - 28/1

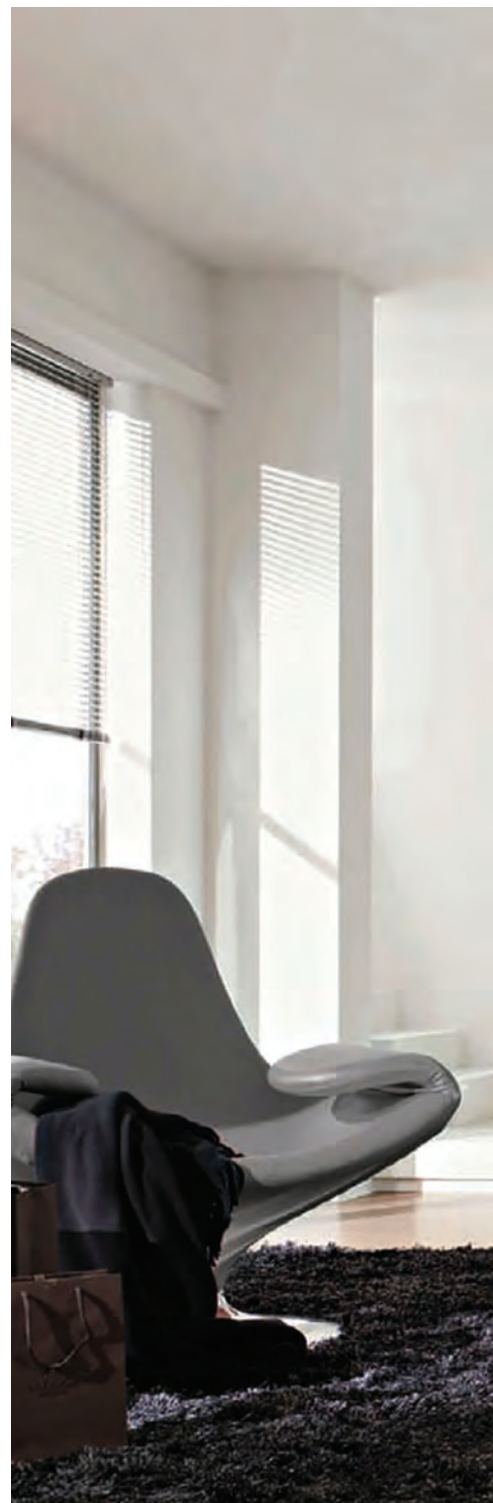

**Κατεύθυνση επιφάνειας:** Κάθετη  
**Υφή επιφάνειας:** Synchro  
**Τύπος πόρτας:** Εσωτερικού χώρου  
**Κωδικός Χρώματος:** EX006 Eiche Ribbeck

**Surface trend:** Vertical  
**Surface:** Synchro  
**Door type:** Interior door  
**Color code:** EX006 Eiche Ribbeck

**Τρόποι μετατροπής:**

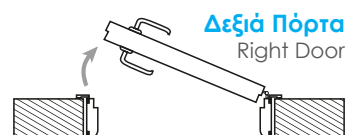
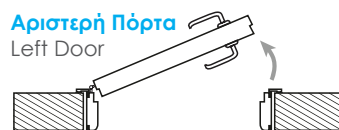



**Τύπος & Διαστάσεις κάσας:**

Case type & dimensions:

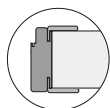

85mm  
100mm  
130mm  
150mm  
180mm  
240mm

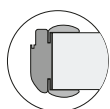

**Κωδ./Code:**

vio 06.01.1120.59







**Τύπος & Διαστάσεις κάσας:**

Case type & dimensions:

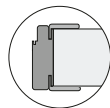

85mm  
100mm  
130mm  
150mm  
180mm  
240mm

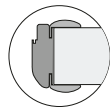

**Κωδ./Code:**

vio 06.01.MK1010.P7





## Ομοιοχρωμία επιφανειών Match Color



• Ειδικό πάνελ  
επιπλοποιίας: 8 - 18 - 25mm

**Διάσταση πάνελ:**  
2800x1220mm

• Special furniture  
panel: 8 - 18 - 25mm  
**Panel dimensions:**  
2800x1220mm

• P.V.C.: 22/1 - 28/1



### Τρόποι μετατροπής:

**Αριστερή Πόρτα**  
Left Door

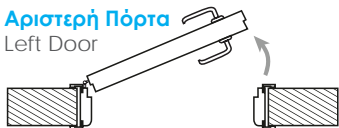

**Δεξιά Πόρτα**  
Right Door

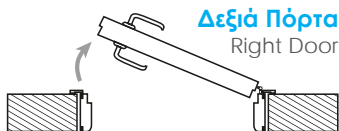

**Κατεύθυνση επιφάνειας:** Κάθετη  
**Υφή επιφάνειας:** Synchro  
**Τύπος πόρτας:** Εσωτερικού χώρου  
**Κωδικός Χρώματος:** EX007 Eiche Ribbeck

**Surface trend:** Vertical  
**Surface:** Synchro  
**Door type:** Interior door  
**Color code:** EX007 Eiche Ribbeck





**Ομοιοχρωμία επιφανειών**  
Match Color



• Ειδικό πάνελ  
επιπλοποιίας: 8 - 18 - 25mm  
**Διάσταση πάνελ:**  
2800x1220mm

• Special furniture  
panel: 8 - 18 - 25mm  
**Panel dimensions:**  
2800x1220mm

• P.V.C.: 22/1 - 28/1



**Κατεύθυνση επιφάνειας:** Κάθετη  
**Υφή επιφάνειας:** Klarlack  
**Τύπος πόρτας:** Εσωτερικού χώρου  
**Κωδικός Χρώματος:** 615 Devine Oak

**Surface trend:** Vertical  
**Surface:** Klarlack  
**Door type:** Interior door  
**Color code:** 615 Devine Oak

**Τρόποι μετατροπής:**

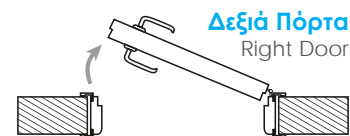
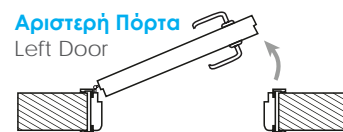





## Τύπος & Διαστάσεις κάσας:

Case type & dimensions:

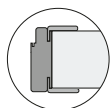

85mm  
100mm  
130mm  
150mm  
180mm  
240mm

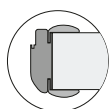

## Κωδ./Code:

vio 06.01.MK803.K4







**Τύπος & Διαστάσεις κάσας:**

Case type & dimensions:

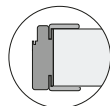

85mm

100mm

130mm

150mm

180mm

240mm

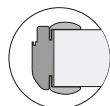

**Κωδ./Code:**

vio PL 06.KZ.1100.P7





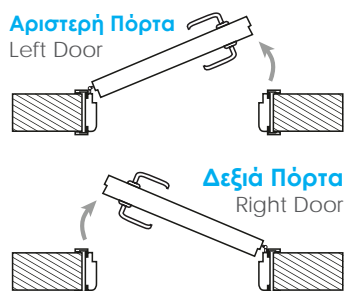

**Κατεύθυνση επιφάνειας:** Κάθετη  
**Υφή επιφάνειας:** Klarlack  
**Τύπος πόρτας:** Εσωτερικού χώρου  
**Κωδικός Χρώματος:** 620 Timeo Pine

**Surface trend:** Vertical  
**Surface:** Klarlack  
**Door type:** Interior door  
**Color code:** 620 Timeo Pine





**Ομοιοχρωμία επιφανειών**  
Match Color



• Ειδικό πάνελ  
επιπλοποιίας: 8 - 18 - 25mm  
**Διάσταση πάνελ:**  
2800x1220mm

• Special furniture  
panel: 8 - 18 - 25mm  
**Panel dimensions:**  
2800x1220mm

• P.V.C.: 22/1 - 28/1



**Κατεύθυνση επιφάνειας:** Κάθετη  
**Υφή επιφάνειας:** Klarlack  
**Τύπος πόρτας:** Εσωτερικού χώρου  
**Κωδικός Χρώματος:** 625 Nussbaum Lumurnba

**Surface trend:** Vertical  
**Surface:** Klarlack  
**Door type:** Interior door  
**Color code:** 625 Nussbaum Lumurnba

**Τρόποι μετατροπής:**

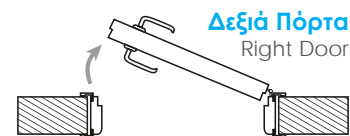
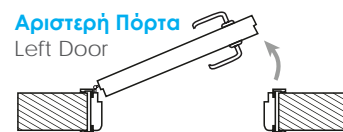



## Τύπος & Διαστάσεις κάσας:

Case type & dimensions:

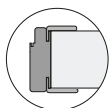

85mm

100mm

130mm

150mm

180mm

240mm

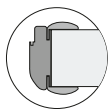

## Κωδ./Code:

vio 06.01.1120.04







**Τύπος & Διαστάσεις κάσας:**

Case type & dimensions:

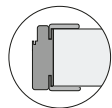

85mm

100mm

130mm

150mm

180mm

240mm

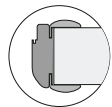

**Κωδ./Code:**

vio 06.01.MK1010.35



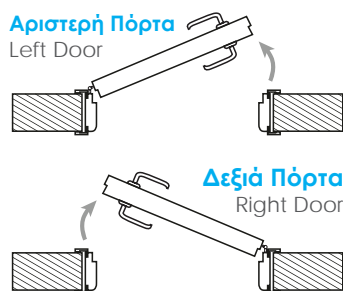

**Κατεύθυνση επιφάνειας:** Κάθετη  
**Υφή επιφάνειας:** Klarlack  
**Τύπος πόρτας:** Εσωτερικού χώρου  
**Κωδικός Χρώματος:** 630 Pino Aurelio

**Surface trend:** Vertical  
**Surface:** Klarlack  
**Door type:** Interior door  
**Color code:** 630 Pino Aurelio





**Ομοιοχρωμία επιφανειών**  
Match Color



• Ειδικό πάνελ  
επιπλοποιίας: 8 - 18 - 25mm  
**Διάσταση πάνελ:**  
2800x1220mm

• Special furniture  
panel: 8 - 18 - 25mm  
**Panel dimensions:**  
2800x1220mm

• P.V.C.: 22/1 - 28/1



**Κατεύθυνση επιφάνειας:** Κάθετη  
**Υφή επιφάνειας:** Haptic  
**Τύπος πόρτας:** Εσωτερικού χώρου  
**Κωδικός Χρώματος:** 635 Andersen Pine

**Surface trend:** Vertical  
**Surface:** Haptic  
**Door type:** Interior door  
**Color code:** 635 Andersen Pine

**Τρόποι μετατροπής:**

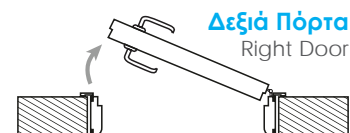



## Τύπος & Διαστάσεις κάσας:

Case type & dimensions:

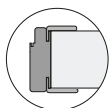

85mm  
100mm  
130mm  
150mm  
180mm  
240mm

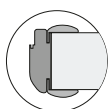

## Κωδ./Code:

via 06.01.770.K3







**Τύπος & Διαστάσεις κάσας:**

Case type & dimensions:

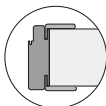

85mm  
100mm  
130mm  
150mm  
180mm  
240mm

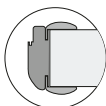

**Κωδ./Code:**

vio 06.01.770.B6





## Ομοιοχρωμία επιφανειών Match Color



• Ειδικό πάνελ  
επιπλοποιίας: 8 - 18 - 25mm  
**Διάσταση πάνελ:**  
2800x1220mm

• Special furniture  
panel: 8 - 18 - 25mm  
**Panel dimensions:**  
2800x1220mm

• P.V.C.: 22/1 - 28/1



**Αριστερή Πόρτα**  
Left Door

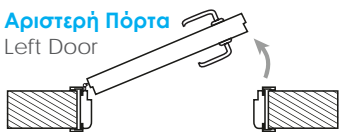

**Δεξιά Πόρτα**  
Right Door

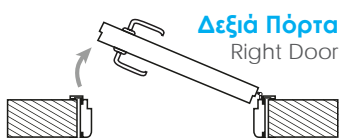

**Κατεύθυνση επιφάνειας:** Κάθετη  
**Υφή επιφάνειας:** Haptic  
**Τύπος πόρτας:** Εσωτερικού χώρου  
**Κωδικός Χρώματος:** 504 Lancaster Oak Bora

**Surface trend:** Vertical  
**Surface:** Haptic  
**Door type:** Interior door  
**Color code:** 504 Lancaster Oak Bora



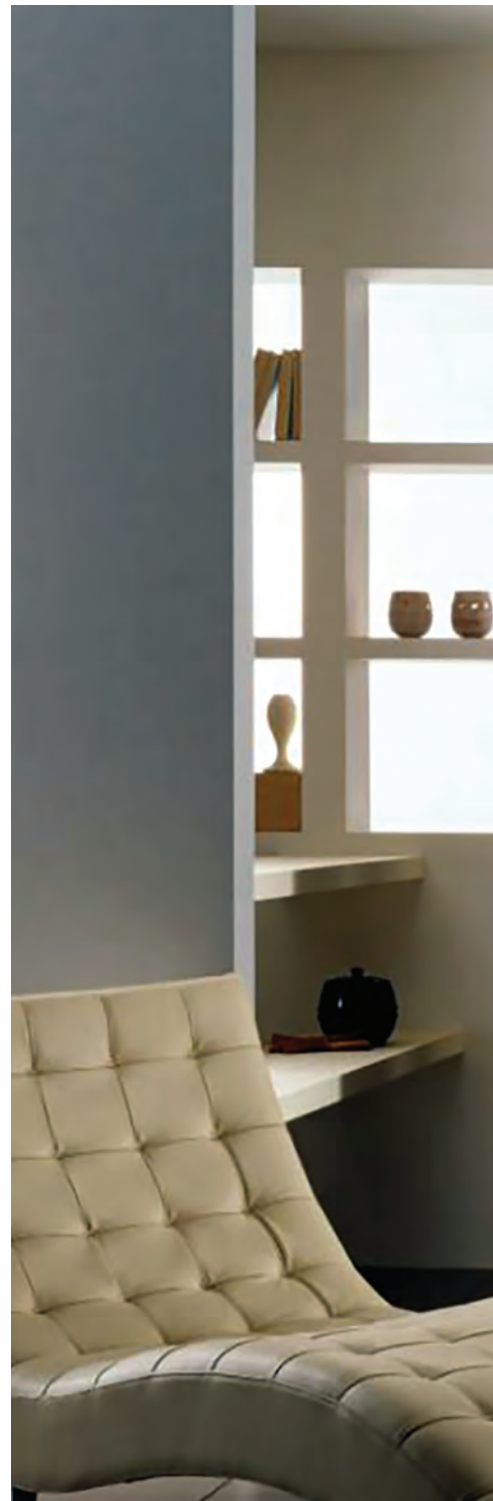

**Κατεύθυνση επιφάνειας:** Κάθετη  
**Υφή επιφάνειας:** Haptic  
**Τύπος πόρτας:** Εσωτερικού χώρου  
**Κωδικός Χρώματος:** 505 Lancaster Oak Bora

**Surface trend:** Vertical  
**Surface:** Haptic  
**Door type:** Interior door  
**Color code:** 505 Lancaster Oak Bora

**Τρόποι μετατροπής:**

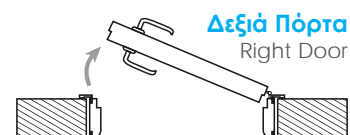
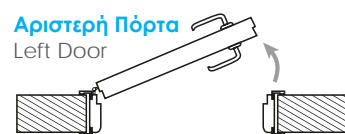



## Τύπος & Διαστάσεις κάσας:

Case type & dimensions:

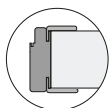

85mm

100mm

130mm

150mm

180mm

240mm

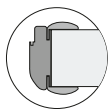

## Κωδ./Code:

via 06.01.460.59







**Τύπος & Διαστάσεις κάσας:**

Case type & dimensions:

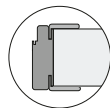

85mm  
100mm  
130mm  
150mm  
180mm  
240mm

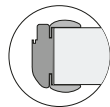

**Κωδ./Code:**

vio 06.01.1110.59





## Τρόποι μετατροπής:

**Αριστερή Πόρτα**  
Left Door

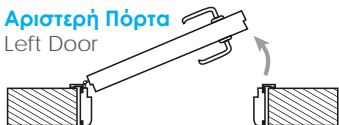

**Δεξιά Πόρτα**  
Right Door

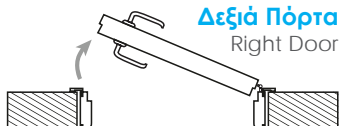

**Κατεύθυνση επιφάνειας:** Κάθετη  
**Υφή επιφάνειας:** Haptic  
**Τύπος πόρτας:** Εσωτερικού χώρου  
**Κωδικός Χρώματος:** 506 Lancaster Oak Bora

**Surface trend:** Vertical  
**Surface:** Haptic  
**Door type:** Interior door  
**Color code:** 506 Lancaster Oak Bora





**Ομοιοχρωμία επιφανειών**  
Match Color

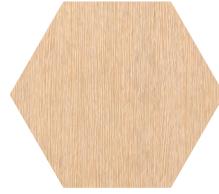

• Ειδικό πάνελ  
επιπλοποιίας: 8 - 18 - 25mm

**Διάσταση πάνελ:**  
2800x1220mm

• Special furniture  
panel: 8 - 18 - 25mm

**Panel dimensions:**  
2800x1220mm

• P.V.C.: 22/1 - 28/1



**Κατεύθυνση επιφάνειας:** Κάθετη & Οριζόντια  
**Υφή επιφάνειας:** Klarlack  
**Τύπος πόρτας:** Εσωτερικού χώρου  
**Κωδικός Χρώματος:** 331 Light Oak

**Surface trend:** Vertical & Horizontal  
**Surface:** Klarlack  
**Door type:** Interior door  
**Color code:** 331 Light Oak

**Τρόποι μετατροπής:**

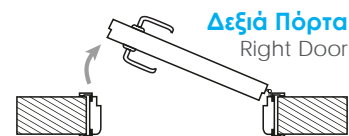
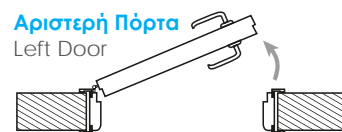



**Τύπος & Διαστάσεις κάσας:**

Case type & dimensions:

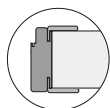

85mm  
100mm  
130mm  
150mm  
180mm  
240mm

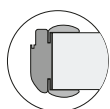

**Κωδ./Code:**

vio PL 06.KZ153.Y6

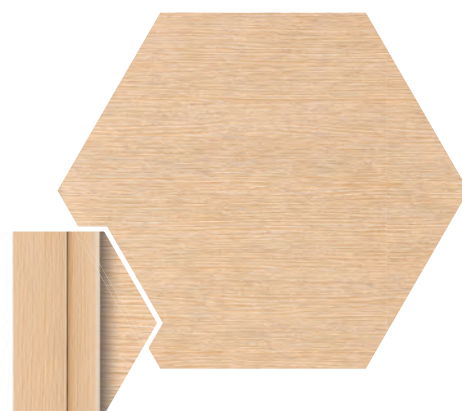





**Τύπος & Διαστάσεις κάσας:**

Case type & dimensions:

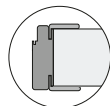

85mm

100mm

130mm

150mm

180mm

240mm

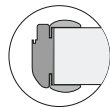

**Κωδ./Code:**

vio PL06.KZ.1030.P7







**Ομοιοχρωμία επιφανειών**  
Match Color



• Ειδικό πάνελ  
επιπλοποιίας: 8 - 18 - 25mm  
**Διάσταση πάνελ:**  
2800x1220mm

• Special furniture  
panel: 8 - 18 - 25mm  
**Panel dimensions:**  
2800x1220mm

• P.V.C.: 22/1 - 28/1



**Τρόποι μετατροπής:**

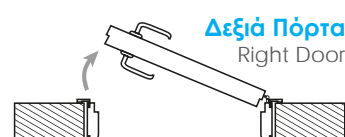

**Κατεύθυνση επιφάνειας:** Κάθετη & Οριζόντια

**Υφή επιφάνειας:** Klarlack

**Τύπος πόρτας:** Εσωτερικού χώρου

**Κωδικός Χρώματος:** 336 Δρυς καφέ

**Surface trend:** Vertical & Horizontal

**Surface:** Klarlack

**Door type:** Interior door

**Color code:** 336 Choco Oak





**Κατεύθυνση επιφάνειας:** Κάθετη & Οριζόντια  
**Υφή επιφάνειας:** Klarlack  
**Τύπος πόρτας:** Εσωτερικού χώρου  
**Κωδικός Χρώματος:** 340 Dark Oak

**Surface trend:** Vertical & Horizontal  
**Surface:** Klarlack  
**Door type:** Interior door  
**Color code:** 340 Dark Oak

**Τρόποι μετατροπής:**

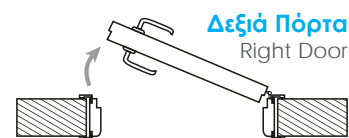



**Τύπος & Διαστάσεις κάσας:**

Case type & dimensions:

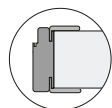

85mm

100mm

130mm

150mm

180mm

240mm

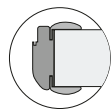

**Κωδ./Code:**

vio PL 06.KZ1020.P7







**Τύπος & Διαστάσεις κάσας:**

Case type & dimensions:

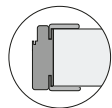

85mm  
100mm  
130mm  
150mm  
180mm  
240mm

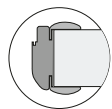

**Κωδ./Code:**

vio 06.01.350.K4



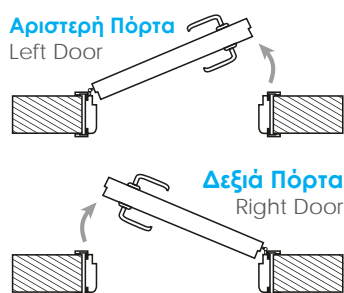

**Κατεύθυνση επιφάνειας:** Κάθετη  
**Υφή επιφάνειας:** Klarlack  
**Τύπος πόρτας:** Εσωτερικού χώρου  
**Κωδικός Χρώματος:** 515 Avela Allover

**Surface trend:** Vertical  
**Surface:** Klarlack  
**Door type:** Interior door  
**Color code:** 515 Avela Allover





**Ομοιοχρωμία επιφανειών**  
Match Color



• Ειδικό πάνελ  
επιπλοποιίας: 8 - 18 - 25mm  
**Διάσταση πάνελ:**  
2800x1220mm

• Special furniture  
panel: 8 - 18 - 25mm  
**Panel dimensions:**  
2800x1220mm

• P.V.C.: 22/1 - 28/1



**Κατεύθυνση επιφάνειας:** Κάθετη  
**Υφή επιφάνειας:** Klarlack  
**Τύπος πόρτας:** Εσωτερικού χώρου  
**Κωδικός Χρώματος:** 610 Lindholm

**Surface trend:** Vertical  
**Surface:** Klarlack  
**Door type:** Interior door  
**Color code:** 610 Lindholm

**Τρόποι μετατροπής:**

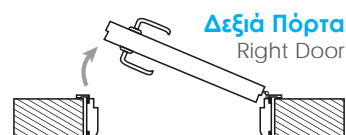



**Τύπος & Διαστάσεις κάσας:**

Case type & dimensions:

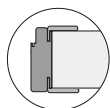

85mm

100mm

130mm

150mm

180mm

240mm

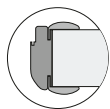

**Κωδ./Code:**

vio 06.01.1110.59







**Τύπος & Διαστάσεις κάσας:**

Case type & dimensions:

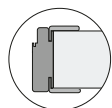

85mm  
100mm  
130mm  
150mm  
180mm  
240mm

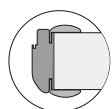

**Κωδ./Code:**

vio 06.01.1120.K4





## Τρόποι μετατροπής:

**Αριστερή Πόρτα**  
Left Door

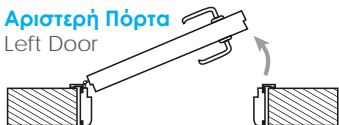

**Δεξιά Πόρτα**  
Right Door

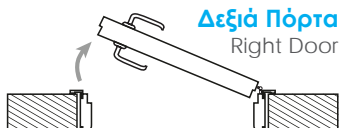

**Κατεύθυνση επιφάνειας:** Κάθετη  
**Υφή επιφάνειας:** Klarlack  
**Τύπος πόρτας:** Εσωτερικού χώρου  
**Κωδικός Χρώματος:** 263 Anigre

**Surface trend:** Vertical  
**Surface:** Klarlack  
**Door type:** Interior door  
**Color code:** 263 Anigre





**Κατεύθυνση επιφάνειας:** Κάθετη  
**Υφή επιφάνειας:** Klarlack  
**Τύπος πόρτας:** Εσωτερικού χώρου  
**Κωδικός Χρώματος:** 275 Κερασιά

**Surface trend:** Vertical  
**Surface:** Klarlack  
**Door type:** Interior door  
**Color code:** 275 Cherry

**Τρόποι μετατροπής:**

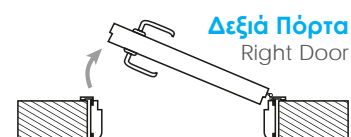
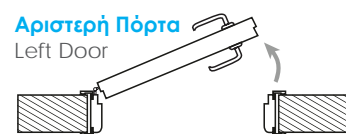



**Τύπος & Διαστάσεις κάσας:**

Case type & dimensions:

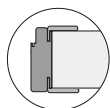

85mm

100mm

130mm

150mm

180mm

240mm

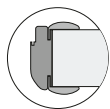

**Κωδ./Code:**

vio PL 06.KZ380.35







**Τύπος & Διαστάσεις κάσας:**

Case type & dimensions:

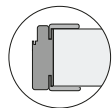

85mm  
100mm  
130mm  
150mm  
180mm  
240mm

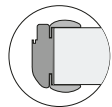

**Κωδ./Code:**

vio 06.01.960.Y2



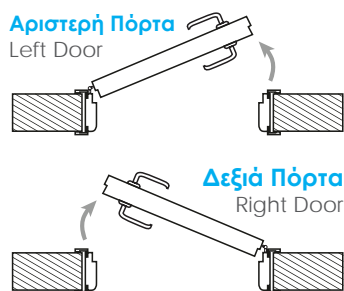

**Υφή επιφάνειας:** Klarlack  
**Τύπος πόρτας:** Εσωτερικού χώρου  
**Κωδικός Χρώματος:** 200 Λευκό

**Surface:** Klarlack  
**Door type:** Interior door  
**Color code:** 200 White





**Υφή επιφάνειας:** Klarlack  
**Τύπος πόρτας:** Εσωτερικού χώρου  
**Κωδικός Χρώματος:** 304 Grey

**Surface:** Klarlack  
**Door type:** Interior door  
**Color code:** 304 Grey

**Τρόποι μετατροπής:**

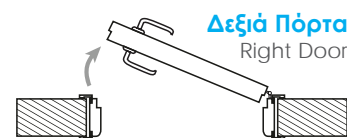



**Τύπος & Διαστάσεις κάσας:**

Case type & dimensions:

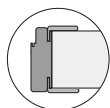

85mm  
100mm  
130mm  
150mm  
180mm  
240mm

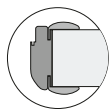

**Κωδ./Code:**

via 06.01.MK950.59

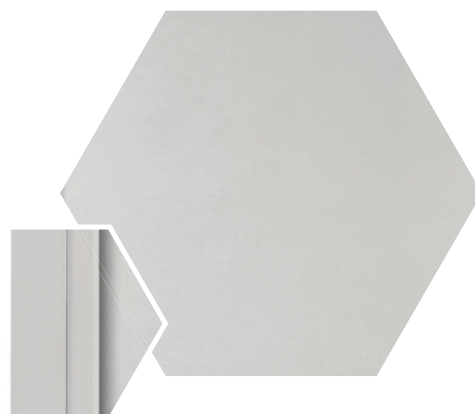



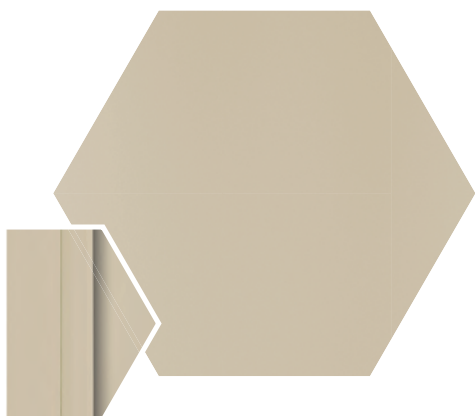

**Τύπος & Διαστάσεις κάσας:**

Case type & dimensions:

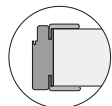

85mm

100mm

130mm

150mm

180mm

240mm

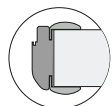

**Κωδ./Code:**

vio 06.01.730.57



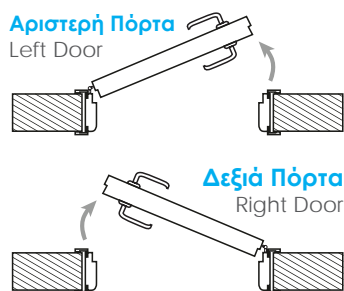

**Υφή επιφάνειας:** Klarlack  
**Τύπος πόρτας:** Εσωτερικού χώρου  
**Κωδικός Χρώματος:** 355 Μπεζ

**Surface:** Klarlack  
**Door type:** Interior door  
**Color code:** 355 Beige



# special doors

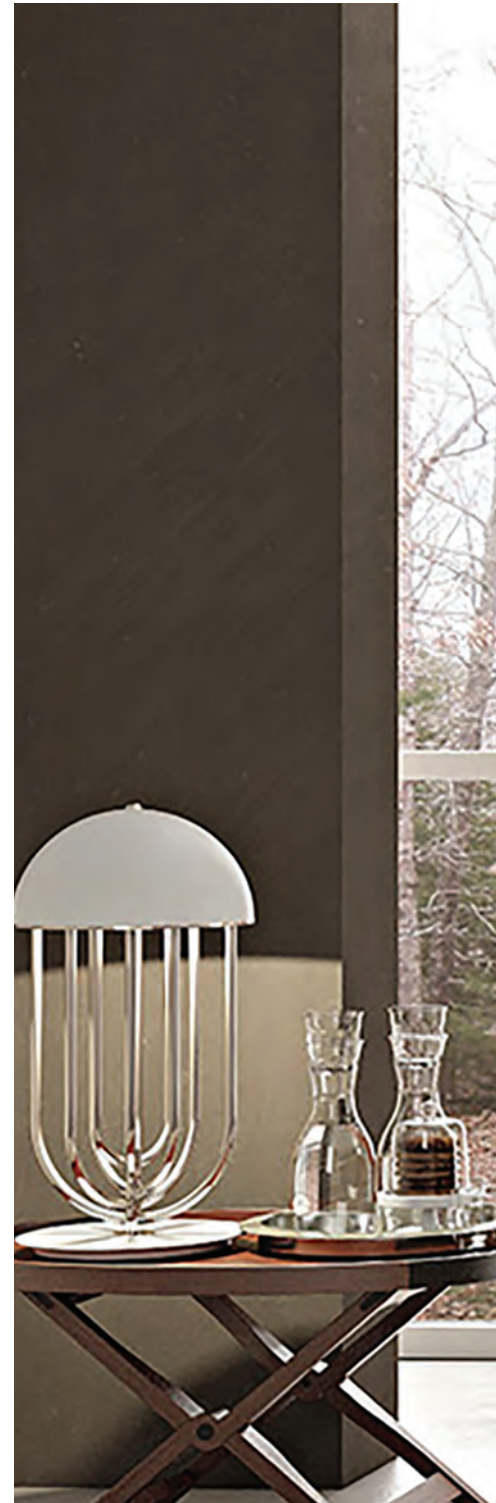

**Τύπος πόρτας:** Συρόμενη χωνευτή

**Door type:** Built - in sliding door

**Τρόποι μετατροπής:**

**Αριστερή Πόρτα**

Left Door

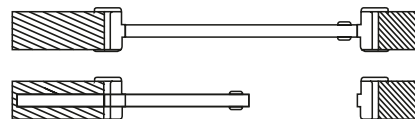

**Δεξιά Πόρτα**

Right Door

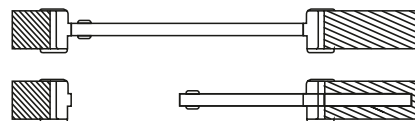



**Τύπος κάσας:**

Case type:

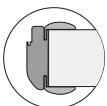
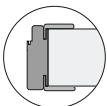

**Χούφτα πόρτας: No 400**

Door sliding: No 400







**Τύπος κάσας:**

Case type:

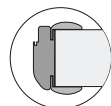
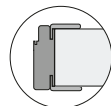

**Κωδ./Code:**

vio 06.01.180.P7



# special doors



## Τρόποι μετατροπής:

Αριστερή Πόρτα  
Left Door

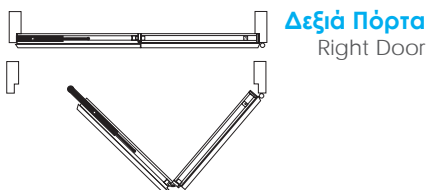

Τύπος πόρτας: Σπαστή ανοιγόμενη

Door type: Folding door



# special doors

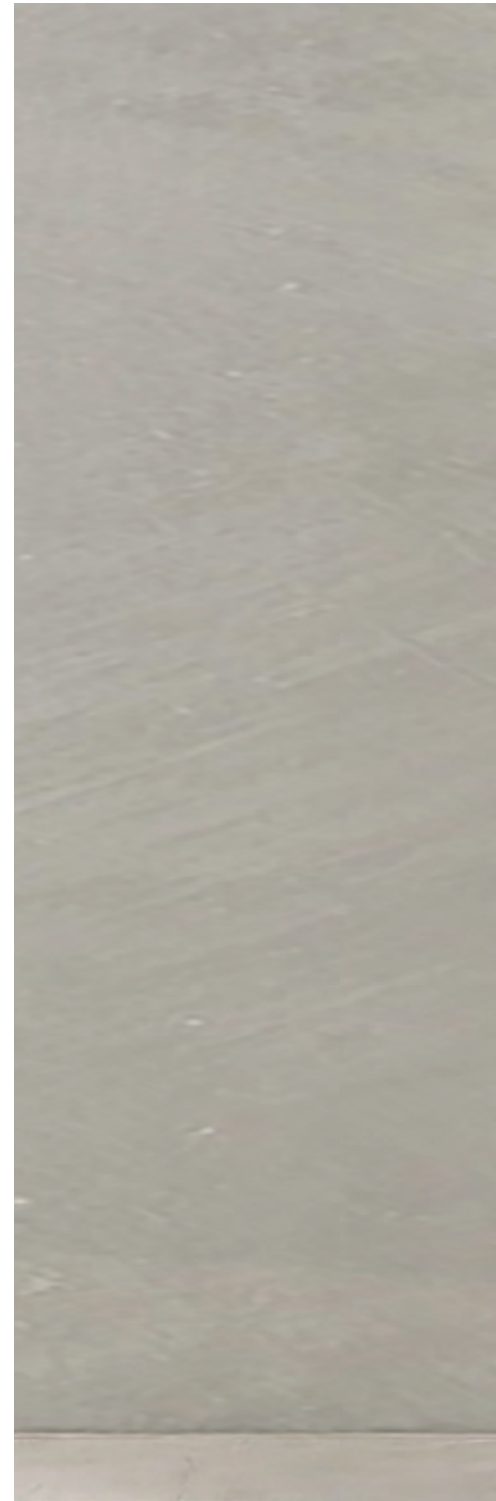

**Τύπος πόρτας:** Συρόμενη εξωτερική

**Door type:** External sliding door

**Τρόποι μετατροπής:**

**Αριστερή Πόρτα**

Left Door

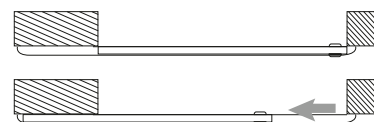

**Δεξιά Πόρτα**

Right Door

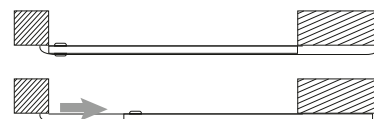



**Τύπος κάσας:**

Case type:

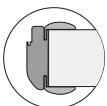
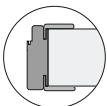

**Χούφτα πόρτας: No 400**

Door sliding: No 400







**Τύπος κάσας:**

Case type:

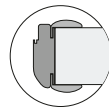
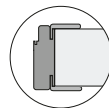

**Κωδ./Code:**

vio 06.01.1120.K4



# special doors

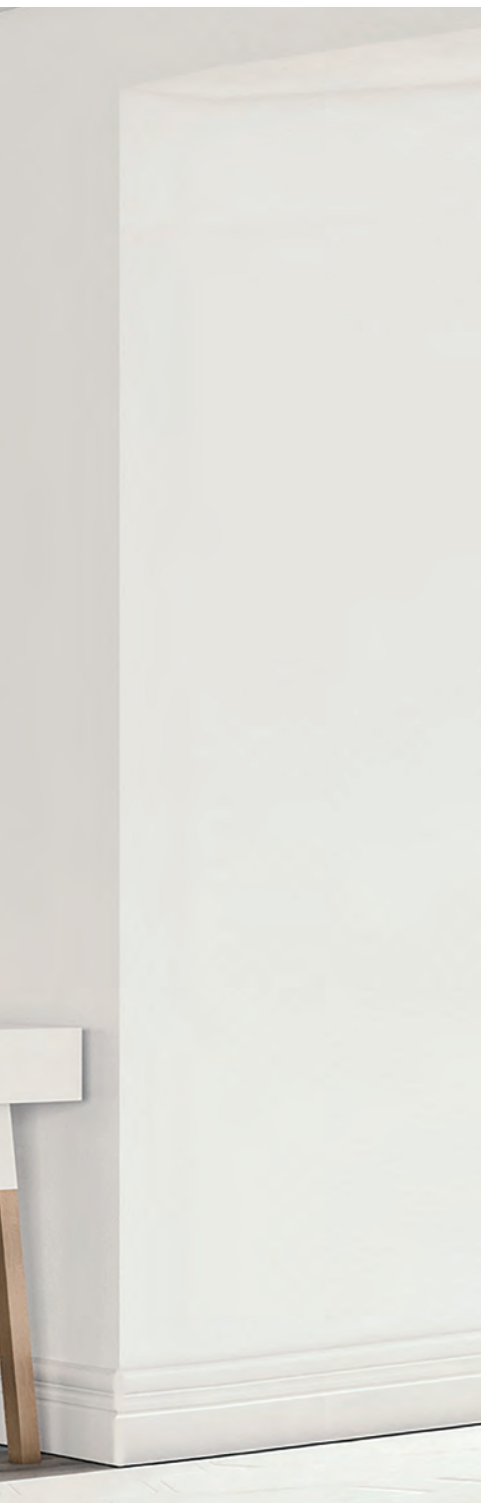

Τύπος παταριού: Δίφυλλο

Loft door type: Double door



Τύπος παταριού: Μονόφυλλο

Loft door type: Single door

Τύπος παταριού:



Μονόφυλλο  
Single door

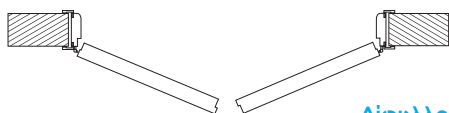

Δίφυλλο  
Double door



# Σχέδια Πορτών

## Door's Decoration



Barbara

Bianca

Briana

Creta

Fiona\*

Ios



Melina

Milos

Milva

Miranda\*

Monica

Naxos



Paola

Ramona

Regina\*

Stefania

Valentina

Valeria

\*Οι πόρτες Fiona - Miranda - Regina διατίθενται με τζάμι αμβολής  
\*Fiona - Miranda - Regina are available with satin glass

# Χρωματολόγιο Πορτών

## Door's Color



ΚΩΔ./ CODE EX001



ΚΩΔ./ CODE EX002



ΚΩΔ./ CODE EX003



ΚΩΔ./ CODE EX004

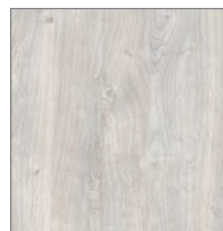

ΚΩΔ./ CODE EX005

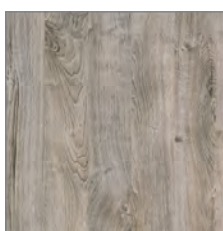

ΚΩΔ./ CODE EX006

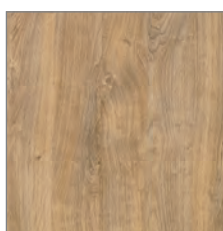

ΚΩΔ./ CODE EX007



ΚΩΔ./ CODE 615



ΚΩΔ./ CODE 620

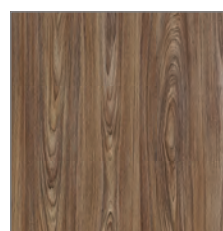

ΚΩΔ./ CODE 625

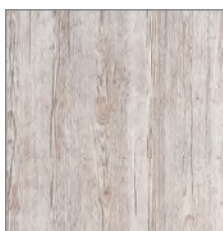

ΚΩΔ./ CODE 630



ΚΩΔ./ CODE 635

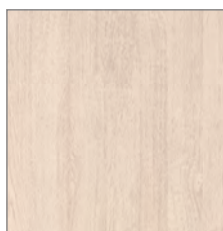

ΚΩΔ./ CODE 504

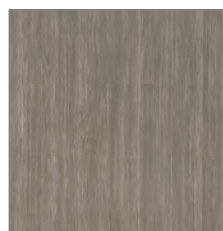

ΚΩΔ./ CODE 505

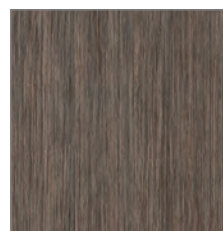

ΚΩΔ./ CODE 506

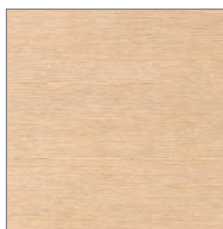

ΚΩΔ./ CODE 331

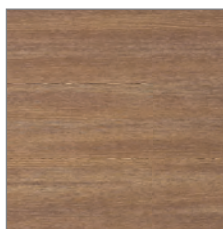

ΚΩΔ./ CODE 336

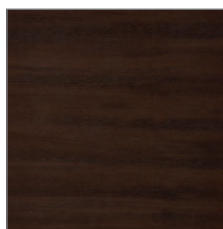

ΚΩΔ./ CODE 340



ΚΩΔ./ CODE 515

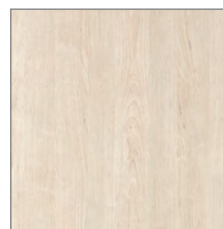

ΚΩΔ./ CODE 610

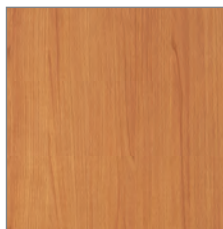

ΚΩΔ./ CODE 263



ΚΩΔ./ CODE 275

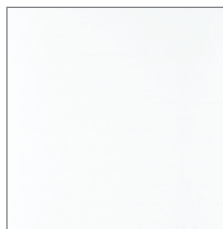

ΚΩΔ./ CODE 200



ΚΩΔ./ CODE 304

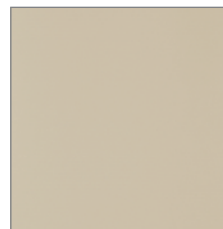

ΚΩΔ./ CODE 355





# Match Color furniture Panels - Gloss & Mat Panels - Worktops

Ομοιοχρωμία πορτών & επιφανειών επιπλοποιίας

## Panels

### Πλεονεκτήματα:

- Ⓜ E1-E0 Certified
- Πυκνότητα Νοβοπαν **680kg/m<sup>3</sup>**
- Πυκνότητα MDF **830kg/m<sup>3</sup>**
- Πάχος φιλμ από **90gr** και άνω
- Όλα τα Πάνελ παρέχονται με **ABS** στο ίδιο χρώμα & υφή [πάχος 0,8mm]

### Advantages:

- Ⓜ E1-E0 Certified
- Density Novopan **680kg/m<sup>3</sup>**
- Density MDF **830kg/m<sup>3</sup>**
- Film thickness of **90gr** and above
- All panels are supplied with **ABS** the same color & texture [thickness 0, 8mm]

## PET<sup>®</sup> Material

### Ιδιαίτερα υλικά για μονόχρωμες επιλογές.

Panel ινοσανίδας 18mm επενδεδυμένο στη μία όψη με **PET<sup>®</sup>** [πολυαιθυλένιο] & κατωφάνεια λευκού χρώματος.

Ειδική μέθοδος παραγωγής & επεξεργασίας χρωμάτων για μοναδικά αποτελέσματα σε ματ

### Special materials for monochrome options.

Panel lined on 18 mm fibreboard one side with **PET<sup>®</sup>** [polyethylene] & white.

Special method of producing & processing colors for unique results in mat

### ΕΙΔΙΚΑ ΧΑΡΑΚΤΗΡΙΣΤΙΚΑ PET<sup>®</sup> & ΠΛΕΟΝΕΚΤΗΜΑΤΑ ΕΝΑΤΙ ΤΟΥ PVC

### SPECIAL FEATURES OF PET<sup>®</sup> & ADVANTAGES ABOUT OF PVC



#### ECO FRIENDLY

Οικολογικό προϊόν πολυαιθυλενίου (PE), μη τοξικό & χημικά ουδέτερο - πλήρως ανακυκλώσιμο

#### ECO FRIENDLY

Ecological product of polyethylene (PE), non-toxic & chemically neutral - fully recyclable



#### ANTI - BACTERIAL

Υγιινό, δεν ευνοεί την ανάπτυξη καθώς & τη μετάδοση βακτηρίων

#### ANTI - BACTERIAL

Healthy, it does not favor growth as well as bacterial transmission



#### EASY CLEAN

Εύκολο καθάρισμα

#### EASY CLEAN

Easy cleaning



#### ANTI - SCRATCH & IMPACT RESISTANCE

Αντοχή σε γρατσουνιές & κρούσεις. Ανθεκτικότερα στις γρατσουνιές από το PVC & το ακρυλικό

#### ANTI - SCRATCH & IMPACT RESISTANCE

Resistance to scratches & impacts. More resistant to scratches than PVC & acrylic



#### RESISTANCE UP TO 4N

Μεγάλης αντοχής έως 4N

#### RESISTANCE UP TO 4N

High strength up to 4N



#### PUB & HEAT RESISTANCE

Αντοχή ενάντια στο φως του ηλίου, την υρασία & την θερμότητα

#### PUB & HEAT RESISTANCE

Resistance against sunlight, immersion & heat



#### SUPERMAT / ANTI - FINGERPRINT

Δεν αφήνει δαχτυλιές

#### SUPERMAT / ANTI - FINGERPRINT

It doesn't leave fingerprints



#### HIGH GLOSS / HIGH REFLECTIVE

Υψηλή & σαφής αντανάκλαση [Καθρέπτης]

#### HIGH GLOSS / HIGH REFLECTIVE

High & clear reflection [Mirror]



# Match Color Panels

Πάνελ κατασκευασμένα από MDF με ιδιαίτερο χαρακτηριστικό την ομοιοχρωμία τους στα decor των εσωτερικών μας πορτών.

Για αυτούς που επιλέγουν την απόλυτη χρωματική αρμονία στο χώρο τους, κατάλληλα για πόρτες κουζίνας, ντουλάπας & έπιπλα.

Panels are made of MDF with special feature their match color in the decor of our interior doors.  
For those who choose the ultimate color harmony in their space, suitable for kitchen doors, wardrobe and furniture.



**Υφή επιφάνειας:** Haptic  
**Κωδικός χρώματος:** EX001 Tadao Scuffy  
**Διάσταση:** 2800x1220mm  
**Πάχος:** 8 - 18 - 25mm

**Surface type:** Haptic  
**Color code:** EX001 Tadao Scuffy  
**Dimension:** 2800x1220mm  
**Thickness:** 8 - 18 - 25mm



**Υφή επιφάνειας:** Haptic  
**Κωδικός χρώματος:** EX002 Tadao Scuffy  
**Διάσταση:** 2800x1220mm  
**Πάχος:** 8 - 18 - 25mm

**Surface type:** Haptic  
**Color code:** EX002 Tadao Scuffy  
**Dimension:** 2800x1220mm  
**Thickness:** 8 - 18 - 25mm



**Υφή επιφάνειας:** Klarlack  
**Κωδικός χρώματος:** EX003 Buntschiefer Monreal  
**Διάσταση:** 2800x1220mm  
**Πάχος:** 8 - 18 - 25mm

**Surface type:** Klarlack  
**Color code:** EX003 Buntschiefer Monreal  
**Dimension:** 2800x1220mm  
**Thickness:** 8 - 18 - 25mm



**Υφή επιφάνειας:** Klarlack  
**Κωδικός χρώματος:** EX004 Buntschiefer Monreal  
**Διάσταση:** 2800x1220mm  
**Πάχος:** 8 - 18 - 25mm

**Surface type:** Klarlack  
**Color code:** EX004 Buntschiefer Monreal  
**Dimension:** 2800x1220mm  
**Thickness:** 8 - 18 - 25mm



**Υφή επιφάνειας:** Synchro  
**Κωδικός χρώματος:** EX005 Eiche Ribbeck  
**Διάσταση:** 2800x1220mm  
**Πάχος:** 8 - 18 - 25mm

**Surface type:** Synchro  
**Color code:** EX005 Eiche Ribbeck  
**Dimension:** 2800x1220mm  
**Thickness:** 8 - 18 - 25mm

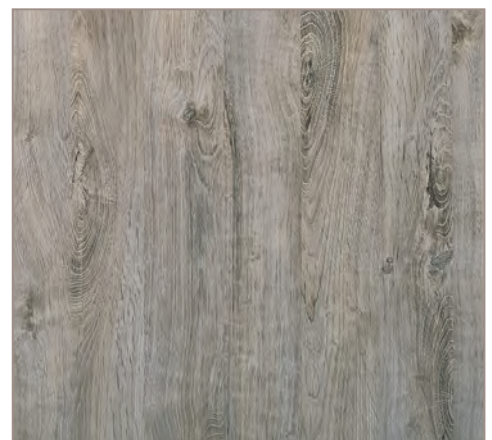

**Υφή επιφάνειας:** Synchro  
**Κωδικός χρώματος:** EX006 Eiche Ribbeck  
**Διάσταση:** 2800x1220mm  
**Πάχος:** 8 - 18 - 25mm

**Surface type:** Synchro  
**Color code:** EX006 Eiche Ribbeck  
**Dimension:** 2800x1220mm  
**Thickness:** 8 - 18 - 25mm



# Ομοιοχρωμία πορτών & επιφανειών επιπλοποιίας

Interior door & Furniture panels match color



**Υφή επιφάνειας:** Synchro  
**Κωδικός χρώματος:** EX007 Eiche Ribbeck  
**Διάσταση:** 2800x1220mm  
**Πάχος:** 8 - 18 - 25mm  
**Surface type:** Synchro  
**Color code:** EX007 Eiche Ribbeck  
**Dimension:** 2800x1220mm  
**Thickness:** 8 - 18 - 25mm

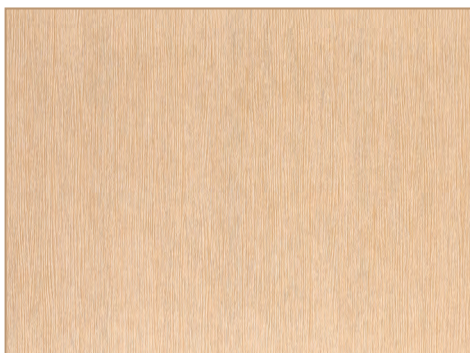

**Υφή επιφάνειας:** Klarlack  
**Κωδικός χρώματος:** 331 Light Oak  
**Διάσταση:** 2800x1220mm  
**Πάχος:** 8 - 18 - 25mm  
**Surface type:** Klarlack  
**Color code:** 331 Light Oak  
**Dimension:** 2800x1220mm  
**Thickness:** 8 - 18 - 25mm

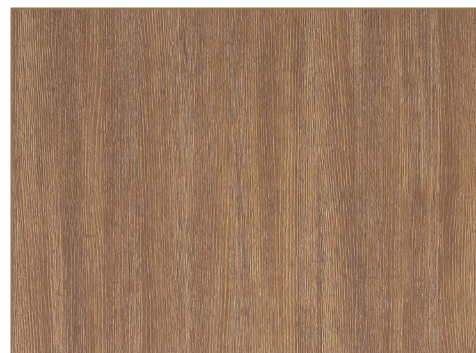

**Υφή επιφάνειας:** Klarlack  
**Κωδικός χρώματος:** 336 Δρυς Καφέ  
**Διάσταση:** 2800x1220mm  
**Πάχος:** 8 - 18 - 25mm  
**Surface type:** Klarlack  
**Color code:** 336 Choco Oak  
**Dimension:** 2800x1220mm  
**Thickness:** 8 - 18 - 25mm

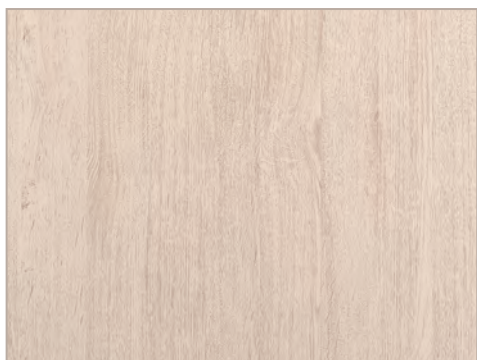

**Υφή επιφάνειας:** Haptic  
**Κωδικός χρώματος:** 504 Lancaster Oak Bora  
**Διάσταση:** 2800x1220mm  
**Πάχος:** 8 - 18 - 25mm  
**Surface type:** Haptic  
**Color code:** 504 Lancaster Oak Bora  
**Dimension:** 2800x1220mm  
**Thickness:** 8 - 18 - 25mm

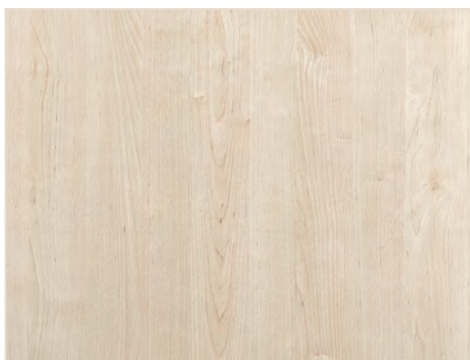

**Υφή επιφάνειας:** Klarlack  
**Κωδικός χρώματος:** 610 Lindholm  
**Διάσταση:** 2800x1220mm  
**Πάχος:** 8 - 18 - 25mm  
**Surface type:** Klarlack  
**Color code:** 610 Lindholm  
**Dimension:** 2800x1220mm  
**Thickness:** 8 - 18 - 25mm



**Υφή επιφάνειας:** Klarlack  
**Κωδικός χρώματος:** 625 Nussbaum Lumumba  
**Διάσταση:** 2800x1220mm  
**Πάχος:** 8 - 18 - 25mm  
**Surface type:** Klarlack  
**Color code:** 625 Nussbaum Lumumba  
**Dimension:** 2800x1220mm  
**Thickness:** 8 - 18 - 25mm

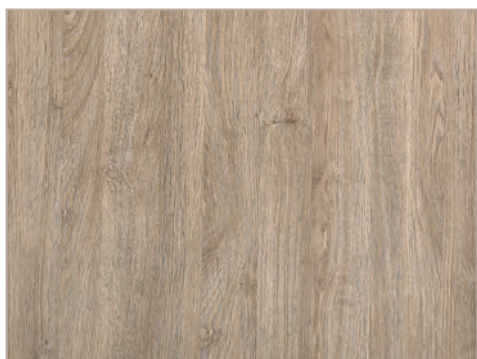

**Υφή επιφάνειας:** Klarlack  
**Κωδικός χρώματος:** 615 Devine Oak  
**Διάσταση:** 2800x1220mm  
**Πάχος:** 8 - 18 - 25mm  
**Surface type:** Klarlack  
**Color code:** 615 Devine Oak  
**Dimension:** 2800x1220mm  
**Thickness:** 8 - 18 - 25mm

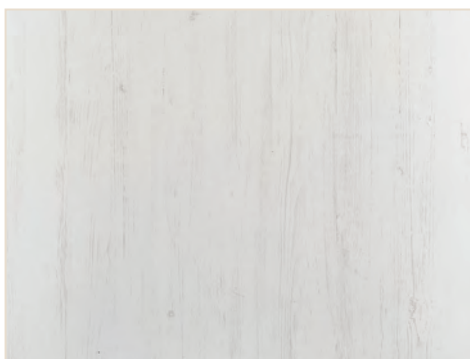

**Υφή επιφάνειας:** Haptic  
**Κωδικός χρώματος:** 635 Andersen Pine  
**Διάσταση:** 2800x1220mm  
**Πάχος:** 8 - 18 - 25mm  
**Surface type:** Haptic  
**Color code:** 635 Andersen Pine  
**Dimension:** 2800x1220mm  
**Thickness:** 8 - 18 - 25mm



# Synchro series

Η σειρά Synchro αποδίδει με το δικό της πιο ρεαλιστικό τρόπο τη δομή & τα νερά του φυσικού ξύλου.

The Synchro series performs in its own more realistic way the structure and the waters of natural wood.



**Τύπος επιφάνειας:** Πάνελ  
**Κωδικός χρώματος:** 700  
**Διάσταση:** 2800x2100mm  
**Πάχος:** 8 - 18 - 25mm

**Surface type:** Panel  
**Color code:** 700  
**Dimension:** 2800x2100mm  
**Thickness:** 8 - 18 - 25mm



**Τύπος επιφάνειας:** Πάνελ  
**Κωδικός χρώματος:** 710  
**Διάσταση:** 2800x2100mm  
**Πάχος:** 8 - 18 - 25mm

**Surface type:** Panel  
**Color code:** 710  
**Dimension:** 2800x2100mm  
**Thickness:** 8 - 18 - 25mm



**Τύπος επιφάνειας:** Πάνελ  
**Κωδικός χρώματος:** 705  
**Διάσταση:** 2800x2100mm  
**Πάχος:** 8 - 18 - 25mm

**Surface type:** Panel  
**Color code:** 705  
**Dimension:** 2800x2100mm  
**Thickness:** 8 - 18 - 25mm



**Τύπος επιφάνειας:** Πάνελ  
**Κωδικός χρώματος:** 715  
**Διάσταση:** 2800x2100mm  
**Πάχος:** 8 - 18 - 25mm

**Surface type:** Panel  
**Color code:** 715  
**Dimension:** 2800x2100mm  
**Thickness:** 8 - 18 - 25mm



## B7 Series

Ένας συνδυασμός χρωμάτων & υφών που προσφέρει προτάσεις τόσο σε μοντέρνες όσο και σε κλασικές επιλογές κατάλληλες για πόρτες κουζίνας - ντουλάπας, έπιπλα

A combination of colors and textures that offers suggestions in both modern and classic choices suitable for kitchen doors - wardrobe, furniture



**Τύπος επιφάνειας:** Πάνελ  
**Κωδικός χρώματος:** 765  
**Διάσταση:** 2800x2100mm  
**Πάχος:** 8 - 18mm  
**Surface type:** Panel  
**Color code:** 765  
**Dimension:** 2800x2100mm  
**Thickness:** 8 - 18mm



**Τύπος επιφάνειας:** Πάνελ  
**Κωδικός χρώματος:** 790  
**Διάσταση:** 2800x2100mm  
**Πάχος:** 8 - 18 - 25mm  
**Surface type:** Panel  
**Color code:** 790  
**Dimension:** 2800x2100mm  
**Thickness:** 8 - 18 - 25mm



**Τύπος επιφάνειας:** Πάνελ  
**Κωδικός χρώματος:** 720  
**Διάσταση:** 2800x2100mm  
**Πάχος:** 8 - 18 - 25mm  
**Surface type:** Panel  
**Color code:** 720  
**Dimension:** 2800x2100mm  
**Thickness:** 8 - 18 - 25mm



**Τύπος επιφάνειας:** Πάνελ  
**Κωδικός χρώματος:** 795  
**Διάσταση:** 2800x2100mm  
**Πάχος:** 8 - 18 - 25mm

**Surface type:** Panel  
**Color code:** 795  
**Dimension:** 2800x2100mm  
**Thickness:** 8 - 18 - 25mm







**Τύπος επιφάνειας:** Πάνελ  
**Κωδικός χρώματος:** 770  
**Διάσταση:** 2800x2100mm  
**Πάχος:** 8 - 18 - 25mm  
**Surface type:** Panel  
**Color code:** 770  
**Dimension:** 2800x2100mm  
**Thickness:** 8 - 18 - 25mm



**Τύπος επιφάνειας:** Πάνελ  
**Κωδικός χρώματος:** 755  
**Διάσταση:** 2800x2100mm  
**Πάχος:** 8 - 18 - 25mm  
**Surface type:** Panel  
**Color code:** 755  
**Dimension:** 2800x2100mm  
**Thickness:** 8 - 18 - 25mm



**Τύπος επιφάνειας:** Πάνελ  
**Κωδικός χρώματος:** 760  
**Διάσταση:** 2800x2100mm  
**Πάχος:** 8 - 18 - 25mm  
**Surface type:** Panel  
**Color code:** 760  
**Dimension:** 2800x2100mm  
**Thickness:** 8 - 18 - 25mm



# Kotton

Υφή πλέγματος ιδανική για εσωτερικό κουζίνας - ντουλάπας, όπως & για ιδιαίτερες κατασκευές.

Mesh texture ideal for interior kitchen-wardrobe, as well as for special constructions.



**Τύπος επιφάνειας:** Πάνελ  
**Κωδικός χρώματος:** 775  
**Διάσταση:** 2800x2100mm  
**Πάχος:** 8 - 18 - 25mm  
**Surface type:** Panel  
**Color code:** 775  
**Dimension:** 2800x2100mm  
**Thickness:** 8 - 18 - 25mm



**Τύπος επιφάνειας:** Πάνελ  
**Κωδικός χρώματος:** 785  
**Διάσταση:** 2800x2100mm  
**Πάχος:** 8 - 18 - 25mm  
**Surface type:** Panel  
**Color code:** 785  
**Dimension:** 2800x2100mm  
**Thickness:** 8 - 18 - 25mm



# B6 Series

Κλασικές επιλογές χρωμάτων με υψηλή ποιότητα υλικών για ευκολία στην κατεργασία

Classic color choices with high quality materials for ease of treatment



**Τύπος επιφάνειας:** Πάνελ  
**Κωδικός χρώματος:** 300  
**Διάσταση:** 3660x1830mm  
**Πάχος:** 8 - 18 - 25mm  
**Surface type:** Panel  
**Color code:** 300  
**Dimension:** 3660x1830mm  
**Thickness:** 8 - 18 - 25mm

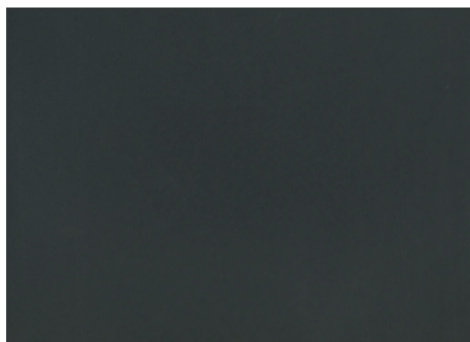

**Τύπος επιφάνειας:** Πάνελ  
**Κωδικός χρώματος:** 400  
**Διάσταση:** 3660x1830mm  
**Πάχος:** 8 - 18 - 25mm  
**Surface type:** Panel  
**Color code:** 400  
**Dimension:** 3660x1830mm  
**Thickness:** 8 - 18 - 25mm



**Τύπος επιφάνειας:** Πάνελ  
**Κωδικός χρώματος:** 100  
**Διάσταση:** 3660x1830mm  
**Πάχος:** 8 - 18 - 25mm  
**Surface type:** Panel  
**Color code:** 100  
**Dimension:** 3660x1830mm  
**Thickness:** 8 - 18 - 25mm



# High Gloss series

Επιφάνειες με υψηλή & σαφή αντανάκλαση με μεγάλη αντοχή σε γρατσουνιές, υγρασία & UV ακτινοβολία. Για τους λάτρεις των γυαλιστερών επιφανειών χωρίς παραμορφώσεις και κυματισμούς. Ιδανικές για τρόφιμα

Surfaces with high and clear reflection with great resistance to scratches, moisture and UV radiation. For fans of glossy surfaces without distortions and ripples. Ideal for food



**Τύπος επιφάνειας:** Pet® Material  
**Κωδικός χρώματος:** 930  
**Διάσταση:** 2800x1220mm  
**Πάχος:** 18mm  
**Surface type:** Pet® Material  
**Color code:** 930  
**Dimension:** 2800x1220mm  
**Thickness:** 18mm

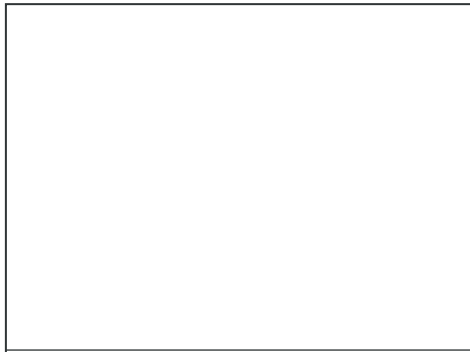

**Τύπος επιφάνειας:** Pet® Material  
**Κωδικός χρώματος:** 900  
**Διάσταση:** 2800x1220mm  
**Πάχος:** 18mm  
**Surface type:** Pet® Material  
**Color code:** 900  
**Dimension:** 2800x1220mm  
**Thickness:** 18mm



**Τύπος επιφάνειας:** Pet® Material  
**Κωδικός χρώματος:** 920  
**Διάσταση:** 2800x1220mm  
**Πάχος:** 18mm  
**Surface type:** Pet® Material  
**Color code:** 920  
**Dimension:** 2800x1220  
**Thickness:** 18mm



**Τύπος επιφάνειας:** Pet® Material  
**Κωδικός χρώματος:** 925  
**Διάσταση:** 2800x1220mm  
**Πάχος:** 18mm  
**Surface type:** Pet® Material  
**Color code:** 925  
**Dimension:** 2800x1220mm  
**Thickness:** 18mm

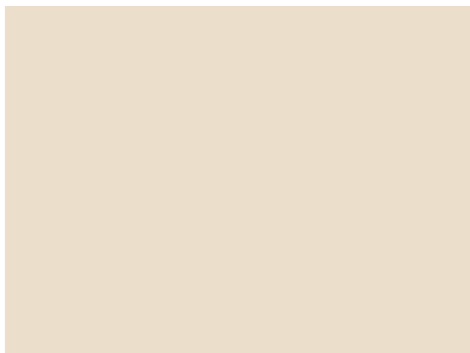

**Τύπος επιφάνειας:** Pet® Material  
**Κωδικός χρώματος:** 905  
**Διάσταση:** 2800x1220mm  
**Πάχος:** 18mm  
**Surface type:** Pet® Material  
**Color code:** 905  
**Dimension:** 2800x1220mm  
**Thickness:** 18mm

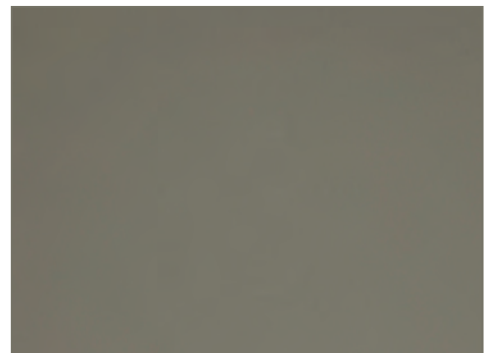

**Τύπος επιφάνειας:** Pet® Material  
**Κωδικός χρώματος:** 910  
**Διάσταση:** 2800x1220mm  
**Πάχος:** 18mm  
**Surface type:** Pet® Material  
**Color code:** 910  
**Dimension:** 2800x1220mm  
**Thickness:** 18mm

## Soft Touch series

Επιφάνειες με μηδενική αντανάκλαση, βελούδινη υφή, μεγάλη αντοχή σε υγρασία, γρατσουνιές, UV ακτινοβολία & δαχτυλιές. Συνιστάται όπου απαιτούνται μονόχρωμες ματ επιλογές υψηλής αισθητικής & αντοχής. Κατάλληλες για τρόφιμα

Surfaces with zero reflection, velvety texture, high resistance to moisture, scratches, UV radiation and fingerprints. It is recommended to require monochrome matte options of high aesthetics and durability. Suitable for food

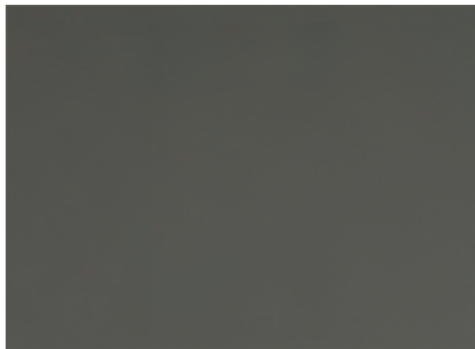

**Τύπος επιφάνειας:** Pet® Material  
**Κωδικός χρώματος:** 915 Mat  
**Διάσταση:** 2800x1220mm  
**Πάχος:** 18mm  
**Surface type:** Pet® Material  
**Color code:** 915 Mat  
**Dimension:** 2800x1220mm  
**Thickness:** 18mm



**Τύπος επιφάνειας:** Pet® Material  
**Κωδικός χρώματος:** 950 Mat  
**Διάσταση:** 2800x1220mm  
**Πάχος:** 18mm  
**Surface type:** Pet® Material  
**Color code:** 950 Mat  
**Dimension:** 2800x1220mm  
**Thickness:** 18mm

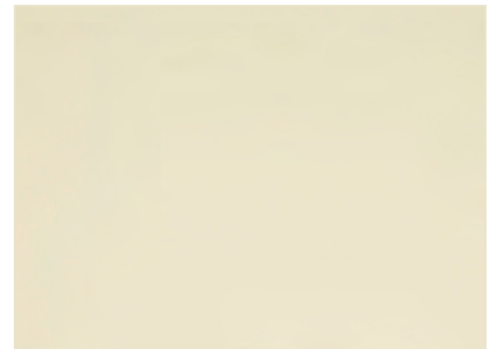

**Τύπος επιφάνειας:** Pet® Material  
**Κωδικός χρώματος:** 910 Mat  
**Διάσταση:** 2800x1220mm  
**Πάχος:** 18mm  
**Surface type:** Pet® Material  
**Color code:** 910 Mat  
**Dimension:** 2800x1220mm  
**Thickness:** 18mm

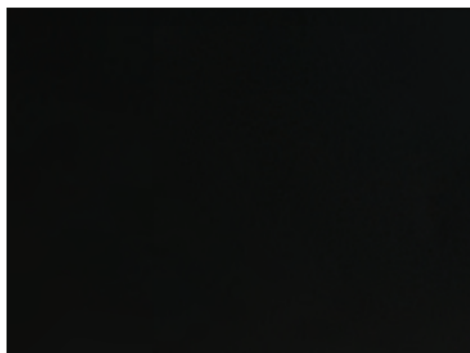

**Τύπος επιφάνειας:** Pet® Material  
**Κωδικός χρώματος:** 915 Mat  
**Διάσταση:** 2800x1220mm  
**Πάχος:** 18mm  
**Surface type:** Pet® Material  
**Color code:** 915 Mat  
**Dimension:** 2800x1220mm  
**Thickness:** 18mm

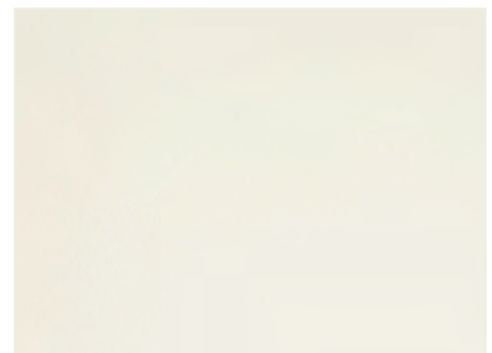

**Τύπος επιφάνειας:** Pet® Material  
**Κωδικός χρώματος:** 935 Mat  
**Διάσταση:** 2800x1220mm  
**Πάχος:** 18mm  
**Surface type:** Pet® Material  
**Color code:** 935 Mat  
**Dimension:** 2800x1220mm  
**Thickness:** 18mm



# Συλλογή πάγκων Worktops collection

Πάγκοι προηγμένης τεχνολογίας μοντέρνου σχεδιασμού, με απόλυτη αδιαβροχοποίηση του πάγκου για μεγαλύτερη αντοχή στην υγρασία.

Countertops of advanced technology modern design, with absolute waterproofing of the countertop for greater resistance to moisture.

## Χαρακτηριστικά Πάγκων: Worktops specifications:



Απαλό άγγιγμα  
Soft touch



Anti-fingerprint



Αντοχή σε γρατσουνιές  
Anti-scratch



Ανθεκτικότητα σε κρούσεις  
Impact resistance

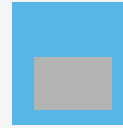

Θερμική επιδιόρθωση μικροεκδορών  
Thermal healing of micro-scratch



Ανθεκτικότητα σε θερμότητα & τριβή  
Heat resistance



Ιδανικό για τρόφιμα  
Suitable for contact with food



Hygienic



Αντιμυκηλικό  
Anti-mold



Αντιβακτηριακές προδιαγραφές  
Anti-bacterial



## Gloss series

Μια σειρά με απόλυτα ρεαλιστική προσομοίωση φυσικών μαρμάρων με υψηλή αντιχαρακτική προστασία

A series of completely realistic simulation of natural marbles with high anti-scratch protection



**Τύπος επιφάνειας:** Πάγκος  
**Κωδικός χρώματος:** 1075  
**Διάσταση:** 3600x600mm  
**Πάχος:** 38mm  
**Surface type:** Worktop  
**Color code:** 1075  
**Dimension:** 3600x600mm  
**Thickness:** 38mm



**Τύπος επιφάνειας:** Πάγκος  
**Κωδικός χρώματος:** 1085  
**Διάσταση:** 3600x600mm  
**Πάχος:** 38mm  
**Surface type:** Worktop  
**Color code:** 1085  
**Dimension:** 3600x600mm  
**Thickness:** 38mm



**Τύπος επιφάνειας:** Πάγκος  
**Κωδικός χρώματος:** 1080  
**Διάσταση:** 3600x600mm  
**Πάχος:** 38mm  
**Surface type:** Worktop  
**Color code:** 1080  
**Dimension:** 3600x600mm  
**Thickness:** 38mm





## Exclusive series

Ιδανικά για κατασκευές που θέλουν να αναδείξουν τα φυσικά υλικά σε συνδυασμό με τη μεγάλη αντοχή.

Ideal for constructions that want to highlight natural materials in combination with great durability.



**Τύπος επιφάνειας:** Πάγκος  
**Κωδικός χρώματος:** 1065  
**Διάσταση:** 4200x600 / 4200x900mm  
**Πάχος:** 38mm  
**Surface type:** Worktop  
**Color code:** 1065  
**Dimension:** 4200x600 / 4200x900mm  
**Thickness:** 38mm

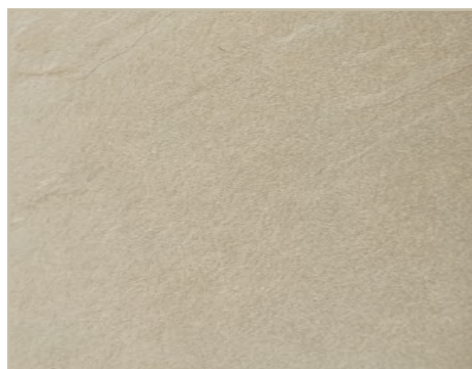

**Τύπος επιφάνειας:** Πάγκος  
**Κωδικός χρώματος:** 1040  
**Διάσταση:** 4200x600 / 4200x900mm  
**Πάχος:** 38mm  
**Surface type:** Worktop  
**Color code:** 1040  
**Dimension:** 4200x600 / 4200x900mm  
**Thickness:** 38mm



**Τύπος επιφάνειας:** Πάγκος  
**Κωδικός χρώματος:** 1045N  
**Διάσταση:** 4200x600 / 4200x900mm  
**Πάχος:** 38mm  
**Surface type:** Worktop  
**Color code:** 1045N  
**Dimension:** 4200x600 / 4200x900mm  
**Thickness:** 38mm

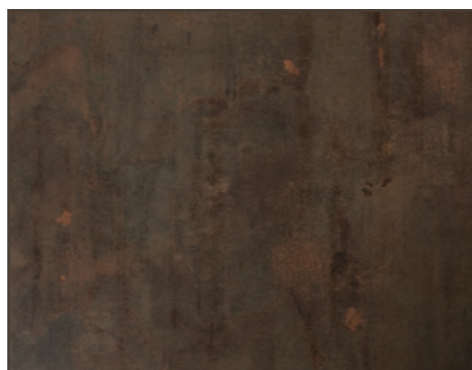

**Τύπος επιφάνειας:** Πάγκος  
**Κωδικός χρώματος:** 1055  
**Διάσταση:** 4200x600 / 4200x900mm  
**Πάχος:** 38mm  
**Surface type:** Worktop  
**Color code:** 1055  
**Dimension:** 4200x600 / 4200x900mm  
**Thickness:** 38mm

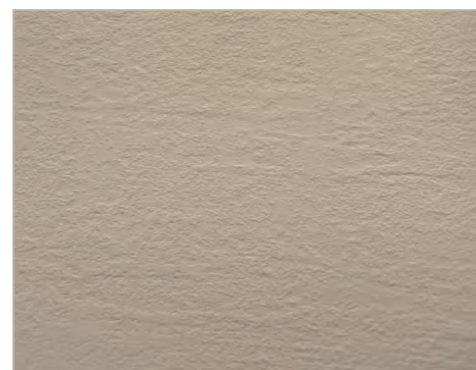

**Τύπος επιφάνειας:** Πάγκος  
**Κωδικός χρώματος:** 1070  
**Διάσταση:** 4200x600 / 4200x900mm  
**Πάχος:** 38mm  
**Surface type:** Worktop  
**Color code:** 1070  
**Dimension:** 4200x600 / 4200x900mm  
**Thickness:** 38mm



## Star series

Μαρμάρινες, ξύλινες, τσιμεντένιες, πετρώματα & φυσικά άλλα χρώματα της σειράς Star προσδίδουν μια από τις πιο ελκυστικές σειρές πάγκων

Marble, wooden, concrete, rocks and of course other colors of the Star series lend one of the most attractive series of benches



**Τύπος επιφάνειας:** Πάγκος  
**Κωδικός χρώματος:** 1095  
**Διάσταση:** 4200x600 / 4200x900mm  
**Πάχος:** 28 - 38mm  
**Surface type:** Worktop  
**Color code:** 1095  
**Dimension:** 4200x600 / 4200x900mm  
**Thickness:** 28 - 38mm



**Τύπος επιφάνειας:** Πάγκος  
**Κωδικός χρώματος:** 1060  
**Διάσταση:** 4200x600 / 4200x900mm  
**Πάχος:** 38mm  
**Surface type:** Worktop  
**Color code:** 1060  
**Dimension:** 4200x600 / 4200x900mm  
**Thickness:** 38mm



**Τύπος επιφάνειας:** Πάγκος  
**Κωδικός χρώματος:** 1090  
**Διάσταση:** 4200x600 / 4200x900mm  
**Πάχος:** 38mm  
**Surface type:** Worktop  
**Color code:** 1090  
**Dimension:** 4200x600 / 4200x900mm  
**Thickness:** 38mm



# Furniture Fittings

Υλικά επιπλοποιίας

**4VIOMETALE**   
HOME | OFFICE | HOTEL

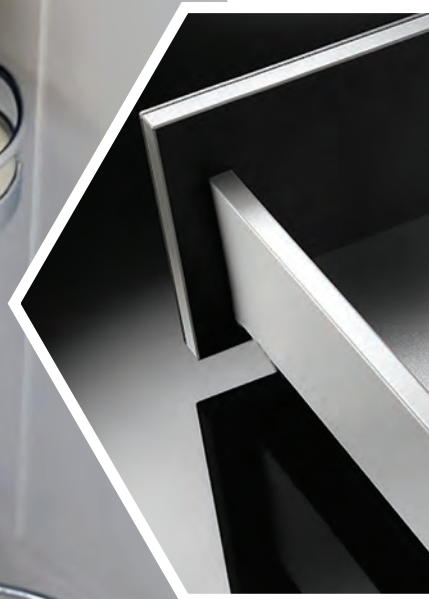





### Συρτάρι φρένο Slim Box

Slim box soft closing

#### ΚΩΔΙΚΟΣ/CODE

02.90.35SG	90x350mm	GREY V4H
02.90.35SW	90x350mm	WHITE V4H
02.90.40SG	90x400mm	GREY V4H
02.90.40SW	90x400mm	WHITE V4H
02.90.45SG	90x450mm	GREY V4H
02.90.45SW	90x450mm	WHITE V4H
02.90.50SG	90x500mm	GREY V4H
02.90.50SW	90x500mm	WHITE V4H
02.128.35SG	128x350mm	GREY V4H
02.128.35SW	128x350mm	WHITE V4H
02.128.40SG	128x400mm	GREY V4H
02.128.40SW	128x400mm	WHITE V4H
02.128.45SG	128x450mm	GREY V4H
02.128.45SW	128x450mm	WHITE V4H

### Συρτάρι φρένο Slim Box

Slim box soft closing

#### ΚΩΔΙΚΟΣ/CODE

02.128.50SG	128x500mm	GREY V4H
02.128.50SW	128x500mm	WHITE V4H
02.128.55SG	128x550mm	GREY V4H
02.128.55SW	128x550mm	WHITE V4H
02.175.35SG	175x350mm	GREY V4H
02.175.35SW	175x350mm	WHITE V4H
02.175.40SG	175x400mm	GREY V4H
02.175.40SW	175x400mm	WHITE V4H
02.175.45SG	175x450mm	GREY V4H
02.175.45SW	175x450mm	WHITE V4H
02.175.50SG	175x500mm	GREY V4H
02.175.50SW	175x500mm	WHITE V4H
02.175.55SG	175x550mm	GREY V4H
02.175.55SW	175x550mm	WHITE V4H

### Μπάρα έκτασης

Rail



#### ΚΩΔΙΚΟΣ/CODE

02.35RG	350mm	GREY V4H
02.35RW	350mm	WHITE V4H
02.40RG	400mm	GREY V4H
02.40RW	400mm	WHITE V4H
02.45RG	450mm	GREY V4H
02.45RW	450mm	WHITE V4H
02.50RG	500mm	GREY V4H
02.50RW	500mm	WHITE V4H
02.55RG	550mm	GREY V4H
02.55RW	550mm	WHITE V4H

**Οδηγός μπίλιας 45mm  
100% έκταση (1x1x1,2mm)**

Ball bearing slide, 45mm, full extension  
(1x1x1,2mm)

ΚΩΔΙΚΟΣ/CODE

02.300.B	300mm
02.350.B	350mm
02.400.B	400mm
02.450.B	450mm
02.500.B	500mm
02.550.B	550mm

**Οδηγός μπίλιας 45mm, φρένο,  
100% έκταση (1x1x1,2mm)**

Ball bearing slide, soft closing 45mm, full  
extension (1x1x1,2mm)

ΚΩΔΙΚΟΣ

CODE

02.300.BΦ	300mm	02.300.BF
02.350.BΦ	350mm	02.350.BF
02.400.BΦ	400mm	02.400.BF
02.450.BΦ	450mm	02.450.BF
02.500.BΦ	500mm	02.500.BF
02.550.BΦ	550mm	02.550.BF

**Οδηγός κρυφός φρένο, 100% έκταση**

Under-mount slide, soft closing, full extension

ΚΩΔΙΚΟΣ

CODE

02.30.Γ	300mm	02.30.G
02.35.Γ	350mm	02.35.G
02.40.Γ	400mm	02.40.G
02.45.Γ	450mm	02.45.G
02.50.Γ	500mm	02.50.G
02.55.Γ	550mm	02.55.G

**Οδηγός κρυφός φρένο, push-open,  
100% έκταση**

Under-mount slide, soft closing, push-open  
full extension

ΚΩΔΙΚΟΣ

CODE

02.50.ΓΠ	500mm	02.50.GP
----------	-------	----------

**Οδηγός ρόδας λευκός 1,2mm Viometale**

Drawer slide, white, 1,2mm Viometale

ΚΩΔΙΚΟΣ/CODE

02.300	300mm	WHITE V4H
02.350	350mm	WHITE V4H
02.400	400mm	WHITE V4H
02.450	450mm	WHITE V4H
02.500	500mm	WHITE V4H
02.550	550mm	WHITE V4H





### Οδηγός metal box απλός λευκός 1,2mm

Metal box drawer slide, white 1,2mm

ΚΩΔΙΚΟΣ/CODE

02.86500 86x500mm

02.118500 118x500mm

02.150500 150x500mm



### Πόδι πλαστικό μαύρο χοντρό & λεπτό σπείρωμα

Black plastic cabinet leg

ΚΩΔΙΚΟΣ/CODE

03.75.B 75 - 100mm

03.100.B 100 - 120mm

03.100.A 100 - 120mm

03.150.B 150 - 180mm

### Φουρκέτα πλαστική μπάζας αλουμινίου

Plastic clip for P.V.C. Alu washboard

ΚΩΔΙΚΟΣ CODE

05.Φ.Κ 05.F.K



### Φουρκέτα πλαστική ξυλόμπαζας

Plastic for clip wooden washboard

ΚΩΔΙΚΟΣ CODE

05.Φ.Ξ 05.F.X

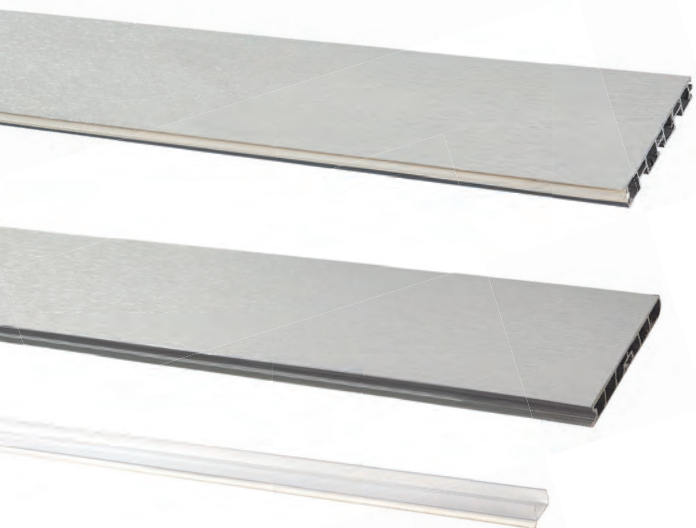

### Μπάζα πλαστική Inox

P.V.C. aluminum washboard

ΚΩΔΙΚΟΣ

05.100.Γ

05.150.B

100mm

150mm

CODE

05.100.G

05.100.B

### Μπαζολάστιχο διάφανο

Transparent washboard rubber

ΚΩΔΙΚΟΣ/CODE

05.16 16mm

05.18 18mm



## Ρυθμιζόμενη γωνία μπάζας 180°

Aluminum plastic corner 180°

ΚΩΔΙΚΟΣ		CODE
05.100.Γ	100mm	05.100.G
05.150.Γ	150mm	05.150.G



## Κουταλοθήκη γκρι

Cutlery tray

ΚΩΔΙΚΟΣ/CODE

06.340	340mm	K.400
06.390	390mm	K.450
06.440	440mm	K.500
06.540	540mm	K.600
06.640	640mm	K.700
06.740	740mm	K.800
06.840	840mm	K.900
06.940	940mm	K.1000
06.1140	1140mm	K.1200

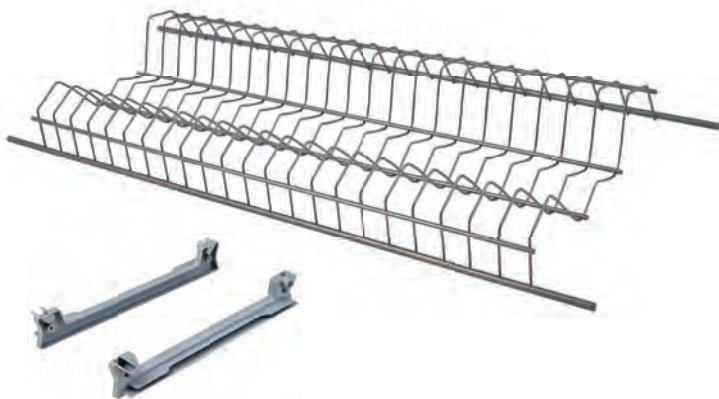

## Πιατοθήκη

Plate rack

ΚΩΔΙΚΟΣ/CODE

07.700	700mm
07.800	800mm
07.900	900mm
07.1000	1.000mm

## Στήριγμα πιατοθήκης

Plate rack bracket

ΚΩΔΙΚΟΣ/CODE

07.100



## Πάτος αλουμινίου

Cabinet alu bottom

ΚΩΔΙΚΟΣ/CODE

09.700	545x700mm
09.800	545x800mm
09.900	545x900mm
09.1000	545x1.000mm
09.1200	545x1.200mm





## Νεροχύτης

Sink

ΚΩΔΙΚΟΣ/CODE

11.1GJ

790x490x180mm

INOX



## Νεροχύτης

Sink

ΚΩΔΙΚΟΣ/CODE

11.1GM

70x430x170mm

INOX



## Νεροχύτης

Sink

ΚΩΔΙΚΟΣ/CODE

11.2G760

760x460x180mm

INOX

11.2G820

820x500x180mm

INOX



## Νεροχύτης

Sink

ΚΩΔΙΚΟΣ/CODE

11.1G

480x430x180mm

INOX



## Αυτόματο δοχείο απορριμάτων 12Lt

Waste container

ΚΩΔΙΚΟΣ/CODE

10.001 PP

10.002 INOX

10.003 ALUMINIUM

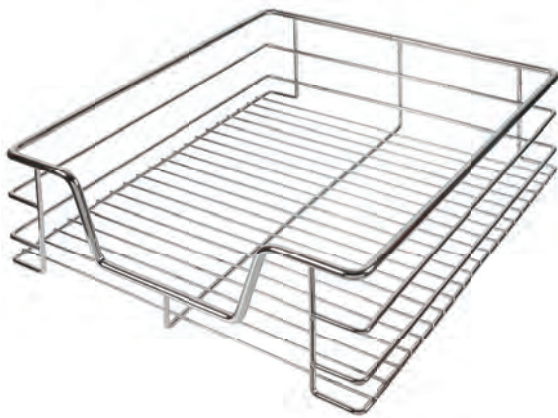

## Συρμάτινο καλάθι τετράπλευρο με φρένο

Wire rack soft closing

ΚΩΔΙΚΟΣ CODE

04.400Φ 400mm 04.400F

04.450Φ 450mm 04.450F

04.500Φ 500mm 04.500F

04.600Φ 600mm 04.600F

04.900Φ 900mm 04.900F



## Συρμάτινο καλάθι τετράπλευρο

Wire rack normal slide

ΚΩΔΙΚΟΣ/CODE

04.400 400mm

04.450 450mm

04.500 500mm

04.600 600mm

04.900 900mm





## Γωνιακό magic corner (φασόλι) με φρένο αριστερό - δεξί

Magic corner kitchen rack, soft closing

ΚΩΔΙΚΟΣ	CODE
04.ΦΑΣ	04.FAS



## Magic corner 45 - 50 με φρένο αριστερό - δεξί

Magic corner 45 -50 left - right  
soft closing

ΚΩΔΙΚΟΣ/CODE
04.MC



## Περιστροφικό 3/4

Revolving wire rack 3/4

ΚΩΔΙΚΟΣ/CODE

04.72	Ø72 INOX
-------	----------

04.82	Ø82 INOX
-------	----------



**Μπουκαλοθήκη χωρίς φρένο  
με οδηγό μπίλιας**

Bottle wire Basket

ΚΩΔΙΚΟΣ/CODE

04.150	470x110x480mm	INOX
04.200	470x160x480mm	INOX



**Κουμπάσο λαδιού**

Gas spring

ΚΩΔΙΚΟΣ/CODE

01.60N 60N

01.80N 80N

01.100N 100N

01.120N 120N

01.150N 150N

01.100NKP 100N



**Κουμπάσο φρένο  
αριστερό - δεξι γκρι**

Door support, soft closing  
left - right

ΚΩΔΙΚΟΣ/CODE

01.KP GREY



**Κουμπάσο βαρέως τύπου 3D  
με φρένο αριστερό - δεξι**

Heavy duty door support,  
3D soft closing left - right

ΚΩΔΙΚΟΣ/CODE

01.BB GREY



**Κουμπάσο με φρένο**

Door support, soft closing  
left - right

ΚΩΔΙΚΟΣ/CODE

01.BL GREY





## Ασανσέρ ντουλάπας 12kg

Wardrobe lift 12kg

ΚΩΔΙΚΟΣ/CODE

21.115B V4H

21.83B V4H

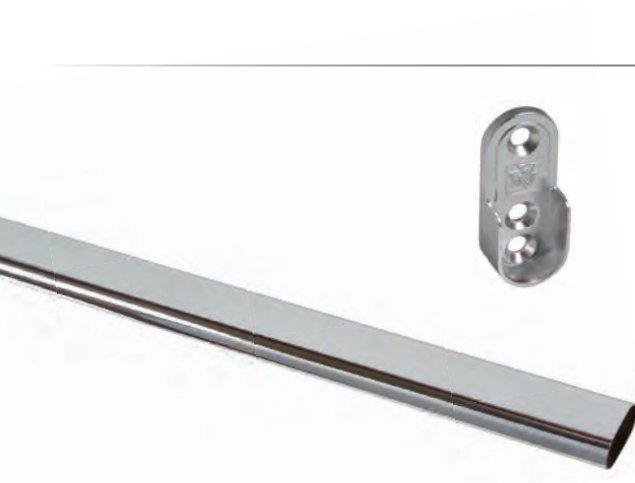

## Στήριγμα ντουλάπας Οβάλ

Hanging rail tube support

ΚΩΔΙΚΟΣ CODE

15.ΣΤΟΒ 15.ΣΤΟV

## Σωλήνα ντουλάπας Οβάλ

Oval wardrobe tube

ΚΩΔΙΚΟΣ

15.ΣΟΒ

30x15x3.000x0,6mm

CODE

15.ΣΟV

## Αναρτήρας ντουλαπιών λευκός

White cabinet suspensor

ΚΩΔΙΚΟΣ/CODE

17.200

## Αναρτήρας ντουλαπιών ρυθμιζόμενος γκρι

Grey regulator cabinet suspensor

ΚΩΔΙΚΟΣ/CODE

17.300

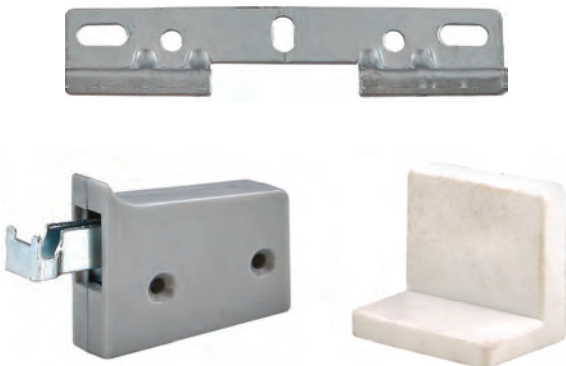

## Μπάρα αναρτήρα

Suspensor Bar

ΚΩΔΙΚΟΣ/CODE

17.305

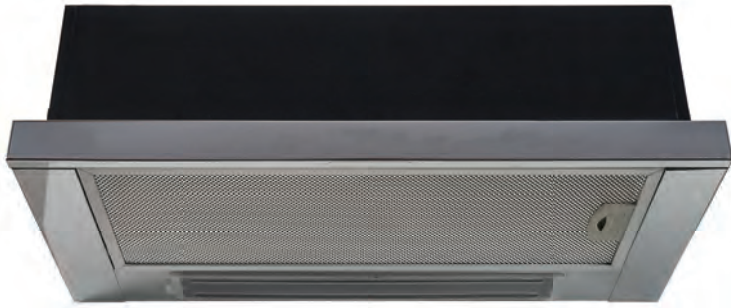

### Απορροφητήρας

Hood

ΚΩΔΙΚΟΣ/CODE

13.2M

2MOTOR - 650m<sup>2</sup>/hrs

INOX



### Σόκορο πάγκου αλουμινίου κολλητό

Edge aluminum counter-top

ΚΩΔΙΚΟΣ/CODE

16.464

4x64mm



### Σόκορο πάγκου αλουμινίου βιδωτό

Edge-threaded aluminum counter-top

ΚΩΔΙΚΟΣ/CODE

16.464<sup>A</sup>

4x64mm



### Ενωτικό πάγκου αλουμινίου

Unifying aluminum counter-top

ΚΩΔΙΚΟΣ/CODE

16.463<sup>A</sup>

4x63mm



HEAVY TYPE



**Μεντεσές φρένο 3D τακάκι clip on H=0**

3D Hinge, fast clip, soft closing H=0

ΚΩΔΙΚΟΣ		CODE
12.16.Φ.Ρ.Τ	Heavy Viometale	12.16.F.P.T
12.8.Φ.Ρ.Τ	Heavy Viometale	12.8.F.P.T
12.0.Φ.Ρ.Τ	Heavy Viometale	12.0.F.P.T

HEAVY TYPE PROFESSIONAL



**Μεντεσές φρένο 3D τακάκι clip on H=0 H=2**

3D Hinge, fast clip, soft closing H=0, H=2

ΚΩΔΙΚΟΣ		CODE
12N.16.Φ.Ρ.Τ	Heavy prof. Viometale	12N.16.F.P.T
12N.8.Φ.Ρ.Τ	Heavy prof. Viometale	12N.8.F.P.T
12N.0.Φ.Ρ.Τ	Heavy prof. Viometale	12N.0.F.P.T

HEAVY TYPE PROFESSIONAL

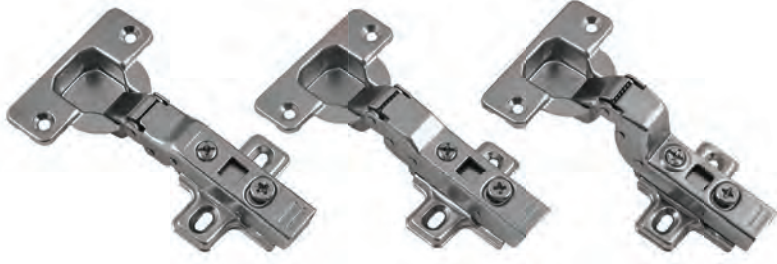

**Μεντεσές φρένο 2D τακάκι clip on H=0 H=2**

2D Hinge, fast clip, soft closing H=0, H=2

ΚΩΔΙΚΟΣ		CODE
12N.16.ΑΠ.Τ.Φ	Heavy prof. Viometale	12N.16.AP.T.F
12N.8.ΑΠ.Τ.Φ	Heavy prof. Viometale	12N.8.AP.T.F
12N.0.ΑΠ.Τ.Φ	Heavy prof. Viometale	12N.0.AP.T.F

HEAVY TYPE



**Μεντεσές χωρίς φρένο 3D τακάκι clip on H=0**

3D Hinge, fast clip, H=0

ΚΩΔΙΚΟΣ / CODE	
12.16.P.T	Heavy Viometale
12.8.P.T	Heavy Viometale
12.0.P.T	Heavy Viometale



**Μεντεσές απλός σχιστός 58gr H=0**

2D Hinge, 58gr, H=0

ΚΩΔΙΚΟΣ		CODE
12.16ΣΧ	Απλός	12.16SX
12.8ΣΧ	Απλός	12.8SX
12.0ΣΧ	Απλός	12.0SX



**Μεντεσές φρένο 2D τακάκι clip on H=0**

2D Hinge, soft closing H=0

ΚΩΔΙΚΟΣ	Viometale	CODE
12.16.ΑΠ.Τ.Φ	Viometale	12.16.ΑΠ.Τ.Φ
12.8.ΑΠ.Τ.Φ	Viometale	12.8.ΑΠ.Τ.Φ
12.0.ΑΠ.Τ.Φ	Viometale	12.0.ΑΠ.Τ.Φ



**Μεντεσές 175° με φρένο**

175° Hinge soft closing

ΚΩΔΙΚΟΣ	CODE
12.170Φ	12.170F



**Μεντεσές κολωνάκι με φρένο**

90° Hinge soft closing

ΚΩΔΙΚΟΣ	CODE
12.ΚΟΛΦ	12.ΚΟΛΦ



**Μεντεσές αντιμέτρου**

135° Hinge

ΚΩΔΙΚΟΣ	CODE
12.ΑΝΤΦ	12.ΑΝΤΦ





## Νοβοπανόβιδες

Chipboard screws

No	No	No	No
3,5x16	4x18	5x40	6x40
3,5x18	4x20	5x50	6x50
3,5x20	4x25	5x60	6x60
3,5x25	4x30		6x70
3,5x30	4x35		6x80
3,5x35	4x40		6x90
3,5x40	4x45		6x100
3,5x45	4x50		
3,5x50	4x60		
3,5x60	4x70		
	4x80		



### Ταινία περιθωρίου με κόλλα 20mm λευκό

PVC edge banding 20mm white with glue

ΚΩΔΙΚΟΣ / CODE

29.KLEY

### Ταινία περιθωρίου χωρίς κόλλα 20mm λευκό

PVC edge banding 20mm white without glue

ΚΩΔΙΚΟΣ / CODE

29.XKLEY

### Ταινία περιθωρίου με κόλλα 20mm έγχρωμη

PVC edge banding 20mm color with glue

ΚΩΔΙΚΟΣ / CODE

29.KEGX

### Ταινία περιθωρίου χωρίς κόλλα 20mm έγχρωμη

PVC edge banding 20mm color without glue

ΚΩΔΙΚΟΣ / CODE

29.XKEGX

## Αμοντάριστη συρόμενη πόρτα ντουλάπας (εξαρτήματα)

Spare parts of wardrobe alu sliding door

ΚΩΔΙΚΟΣ/CODE

59100\*

\* Στον κωδικό περιλαμβάνονται τα profile αλουμινίου, 2 διαχωριστικά, οδηγί, λάστιχα, ροδάκια & βίδες

\* Ελάχιστη χρέωση 3m<sup>2</sup>

\* Included alu profile, 2 traverse, drivers, glides, rubbers & screws

\* Minimum charge 3m<sup>2</sup>



## Αμοντάριστο πορτάκι VIVALDI με οβάλ profile αλουμινίου (εξαρτήματα)



VIVALDI not assembled alu cabinet door (Spare parts)



ΚΩΔΙΚΟΣ/CODE  
502100/59\*

\* Στον κωδικό περιλαμβάνονται τα profile αλουμινίου το τρύπημα του μεντεσέ, τα λάστιχα & τα λαμάκια. Να αναφέρεται πάντα αν το τρύπημα μεντεσέ είναι για κουμπάσο

\* Included alu profiles, hinges, drill, rubbers & blades



## Αμοντάριστο πορτάκι DA VINCI με ίσιο profile αλουμινίου (εξαρτήματα)

DA VINCI not assembled alu cabinet door (Spare parts)



ΚΩΔΙΚΟΣ/CODE  
501100/59\*

\* Στον κωδικό περιλαμβάνονται τα profile αλουμινίου το τρύπημα του μεντεσέ, τα λάστιχα & τα λαμάκια. Να αναφέρεται πάντα αν το τρύπημα μεντεσέ είναι για κουμπάσο

\* Included alu profiles, hinges, drill, rubbers & blades



No H1 Σατινέ / Satin



No 08 Μαύρο / Black



No K6 Ασημί / Silver



No 07 Κόκκινο / Red



No T2 Μπεζ / Beige



No B4 Καθρέφτης / Mirror





**RO vio 06.830** Νικελ ματ / Nickel mat



**RO vio 06.460** Νικελ ματ / Nickel mat



**RO vio 06.830** Όρο ματ / Oro mat



**RO vio 06.460** Όρο ματ / Oro mat



**RO vio 06.350** Μαύρο ματ / Black mat



**RO vio 06.460** Μπρονζε / Bronze



**PL vio 06.460**  
Νικελ ματ / Nickel mat



**RO vio 06.350** Νικελ ματ / Nickel mat



**RO vio 06.930** Νικελ ματ / Nickel mat



**RO vio 06.803** Νικελ ματ / Nickel mat



**Μαγνητικό stop πόρτας**

Magnetic door stop

Νικελ ματ / Nickel mat

18.05.59

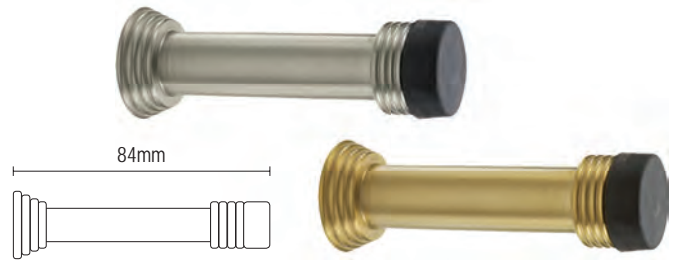

**Stop πόρτας τοίχου**

Wall door stop

Νικελ ματ / Nickel mat 18.03.59

Όρο ματ / Oro mat 18.03.57

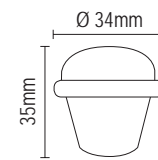

**Stop πόρτας δαπέδου**

Floor door stop

Νικελ ματ / Nickel mat 18.01.59

Όρο ματ / Oro mat 18.01.57

Μπρονζέ / Bronze 18.01.T8



**Χούφτα πόρτας**

Door sliding

Με κλειδαρότρυπα  
With key hole

**No 400**

Χωρίς κλειδαρότρυπα  
With out key hole

ΜΚ09.17.59

Νικελ ματ / Nickel mat

ΧΚ09.18.59

ΜΚ09.17.57

Όρο ματ / Oro mat

ΧΚ09.18.57

ΜΚ09.17.T8

Μπρονζέ / Bronze

ΧΚ09.18.T8

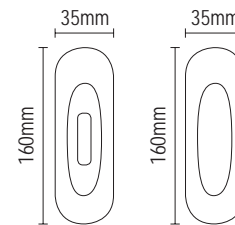

**Χούφτα πόρτας**

Door sliding

Με κλειδαρότρυπα  
With key hole

**No 500**

Χωρίς κλειδαρότρυπα  
With out key hole

ΜΚ09.19.59

Νικελ ματ / Nickel mat

ΧΚ09.20.59

ΜΚ09.19.57

Όρο ματ / Oro mat

ΧΚ09.20.57

ΜΚ09.19.K4

Μαύρο ματ / Black mat

ΧΚ09.20.K4

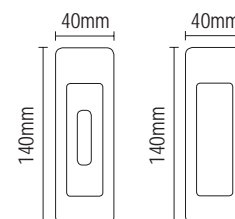



vio 01.157

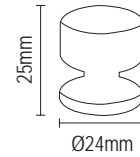

Νικελ ματ / Nickel mat  
01.157/24.59    Ø24mm

Όρο ματ / Oro mat  
01.157/24.57    Ø24mm

Μπρονζε / Bronze  
01.157/24.18    Ø24mm

vio 01.147

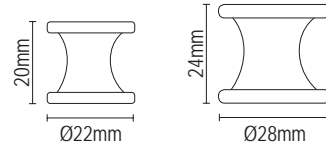

Νικελ ματ / Nickel mat  
01.147/22.59    Ø22mm  
01.147/28.59    Ø28mm

Όρο ματ / Oro mat  
01.147/22.57    Ø22mm  
01.147/28.57    Ø28mm

Μαύρο ματ / Black mat  
01.147/22.K4    Ø22mm  
01.147/28.K4    Ø28mm

vio 01.146

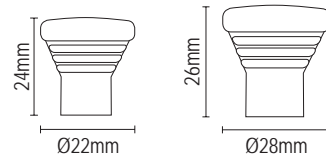

Νικελ ματ / Nickel mat  
01.146/22.59    Ø22mm  
01.146/28.59    Ø28mm

Χρώμιο / Chrome  
01.146/22.04    Ø22mm  
01.146/28.04    Ø28mm

vio 01.114

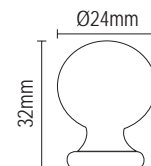

Νικελ ματ / Nickel mat  
01.114/24.59    Ø24mm

Όρο ματ / Oro mat  
01.114/24.57    Ø24mm

Μαύρο ματ / Black mat  
01.114/24.08    Ø24mm

Άσπρο / White  
01.114/24.06    Ø24mm

vio 01.111

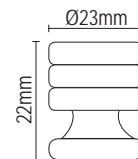

Νικελ ματ / Nickel mat  
01.111/23.59    Ø23mm

Όρο ματ / Oro mat  
01.111/23.57    Ø23mm

Χρώμιο / Chrome  
01.111/23.04    Ø23mm

vio 05.65

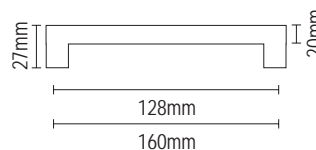

Νικελ ματ / Nickel mat  
05.65/128.59    128mm  
05.65/160.59    160mm

Μαύρο ματ / Black mat  
05.65/128.K4    128mm  
05.65/160.K4    160mm

vio 05.56

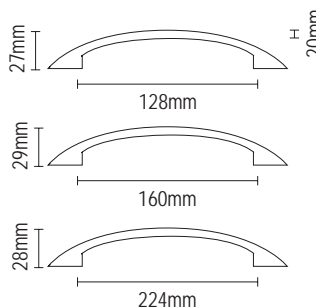

Νικελ ματ / Nickel mat  
05.56/128.59    128mm  
05.56/160.59    160mm  
05.56/224.59    224mm

Όρο ματ / Oro mat  
05.56/128.57    128mm  
05.56/160.57    160mm  
05.56/224.57    224mm

Χρώμιο / Chrome  
05.56/128.04    128mm  
05.56/160.04    160mm  
05.56/224.04    224mm

Μπρονζέ / Bronze  
05.56/128.T8    128mm  
05.56/160.T8    160mm

Μαύρο ματ / Black mat  
05.56/128.K4    128mm  
05.56/160.K4    160mm



vio 05.54

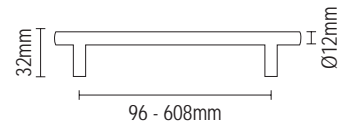

Νικελ ματ / Nickel mat

05.54/96.59 96mm

05.54/128.59 128mm

05.54/160.59 160mm

05.54/192.59 192mm

05.54/224.59 224mm

05.54/320.59 320mm

05.54/608.59 608mm

vio 05.44

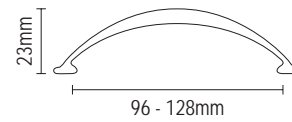

Νικελ ματ / Nickel mat

05.44/96.59 96mm

05.44/128.59 128mm

Όρο ματ / Oro mat

05.44/96.57 96mm

05.44/128.57 128mm

vio 05.05

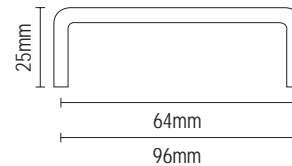

Νικελ ματ / Nickel mat

05.05/64.59 64mm

05.05/96.59 96mm

Όρο ματ / Oro mat

05.05/64.57 64mm

05.05/96.57 96mm

Άσπρο / White

05.05/64.06 64mm

05.05/96.06 96mm

Μαύρο ματ / Black mat

05.05/64.K4 64mm

05.05/96.K4 96mm







57 χλμ. Εθν. οδού Αθηνών - Θεσσαλονίκης  
Οινόφυτα Τ.Κ. 320 11

(Παράδρομος Οινόφυτων - Σχηματαρίου)

☎: 22620 32860

☎: 22620 32868

57 km N.R. Athens - Salonica

GR 320 11, Inofyta - Greece

☎: (+30) 22620 32860

☎: (+30) 22620 32868

✉: [doors@viometale.gr](mailto:doors@viometale.gr) - [4home@viometale.gr](mailto:4home@viometale.gr)

f : [www.facebook.com/Viometale4home/](https://www.facebook.com/Viometale4home/)

[www.viometale4home.gr](http://www.viometale4home.gr)

